



United States Department of Agriculture

# Performance of Structural Insulated Panel Walls under Seismic Loading

Douglas R. Rammer  
Tom Williamson



bildlove – stock.adobe.com



Forest  
Service

Forest Products  
Laboratory

Research Paper  
FPL–RP–704

September  
2020

## Abstract

Structural insulated panels (SIPs) are a viable, energy-efficient, cost-effective option for commercial and residential buildings. But, acceptance of SIPs has been hindered by the lack of systematic evaluation of lateral load performance in wall applications. This study provides the data needed to characterize lateral load performance of several configurations of SIP walls: single-panel walls with and without hold-downs at various aspect ratios, multiple-panel walls without openings, and multiple-panel walls with various openings. This research involved lateral testing of 54 full-sized SIP walls. Single-panel SIP walls with hold-downs had unit strength capacities at least three times that of single-panel SIP walls without hold-downs. Unit shear wall capacity and stiffness of SIP shear wall segments decreased with increasing number of panels and with increasing aspect ratio. Lateral load resistance of single-panel SIP walls with aspect ratios of 1:1, 2:1, and 3:1 and five-panel SIP wall configurations without openings satisfied the cyclic performance parameters of overstrength, drift, and ductility capacities, as defined in International Code Council-Evaluation Service acceptance criteria AC04 and ASTM D7989, which is equivalent to light-frame walls. The perforated shear wall method gave conservative results for all strength ratio predictions; therefore, applying this approach to SIP wall configurations with openings for both stiffness and strength adjustments was determined to be appropriate.

September 2020

Rammer, Douglas R.; Williamson, Tom. 2020. Performance of structural insulated panel walls under seismic loading. Research Paper FPL-RP-704. Madison, WI: U.S. Department of Agriculture, Forest Service, Forest Products Laboratory. 60 p.

A limited number of free copies of this publication are available to the public from the Forest Products Laboratory, One Gifford Pinchot Drive, Madison, WI 53726-2398. This publication is also available online at [www.fpl.fs.fed.us](http://www.fpl.fs.fed.us). Laboratory publications are sent to hundreds of libraries in the United States and elsewhere.

The Forest Products Laboratory is maintained in cooperation with the University of Wisconsin.

The use of trade or firm names in this publication is for reader information and does not imply endorsement by the United States Department of Agriculture (USDA) of any product or service.

Keywords: cyclic performance, drift, ductility, full bearing, overstrength, structural insulated panel (SIP), perforated shear wall design, aspect ratio, multiple-panel walls, lateral testing

## Acknowledgments

This work is a joint research project of USDA Forest Service, Forest Products Laboratory, and the Structural Insulated Panel Association (SIPA). This research was supported in part by funds provided by the Forest Products Laboratory and by the contribution of test panels from SIPA.

## Contents

Introduction.....	1
Background of Previous Research .....	1
Objective .....	3
Experimental Procedures .....	3
Results.....	7
Observations and Failures.....	15
Discussion.....	16
Conclusions.....	25
Literature Cited .....	26
Appendix A—Observations and Failure Modes for Various Wall Configurations.....	27
Appendix B—Tables and Curves for EEEP Curves for All SIP Configurations.....	31
Appendix C—Tables and Curves for Modified Stewart Parameters for All SIP Configurations.....	40
Appendix D—Hold-Down Forces Relative to Applied Load for Configurations with Hold-Downs.....	47

In accordance with Federal civil rights law and U.S. Department of Agriculture (USDA) civil rights regulations and policies, the USDA, its Agencies, offices, and employees, and institutions participating in or administering USDA programs are prohibited from discriminating based on race, color, national origin, religion, sex, gender identity (including gender expression), sexual orientation, disability, age, marital status, family/parental status, income derived from a public assistance program, political beliefs, or reprisal or retaliation for prior civil rights activity, in any program or activity conducted or funded by USDA (not all bases apply to all programs). Remedies and complaint filing deadlines vary by program or incident.

Persons with disabilities who require alternative means of communication for program information (e.g., Braille, large print, audiotape, American Sign Language, etc.) should contact the responsible Agency or USDA's TARGET Center at (202) 720-2600 (voice and TTY) or contact USDA through the Federal Relay Service at (800) 877-8339. Additionally, program information may be made available in languages other than English.

To file a program discrimination complaint, complete the USDA Program Discrimination Complaint Form, AD-3027, found online at [http://www.ascr.usda.gov/complaint\\_filing\\_cust.html](http://www.ascr.usda.gov/complaint_filing_cust.html) and at any USDA office or write a letter addressed to USDA and provide in the letter all of the information requested in the form. To request a copy of the complaint form, call (866) 632-9992. Submit your completed form or letter to USDA by: (1) mail: U.S. Department of Agriculture, Office of the Assistant Secretary for Civil Rights, 1400 Independence Avenue, SW, Washington, D.C. 20250-9410; (2) fax: (202) 690-7442; or (3) email: [program.intake@usda.gov](mailto:program.intake@usda.gov).

USDA is an equal opportunity provider, employer, and lender.

# Performance of Structural Insulated Panel Walls under Seismic Loading

**Douglas R. Rammer**, Research General Engineer  
USDA Forest Service, Forest Products Laboratory, Madison, Wisconsin, USA

**Tom Williamson**, Professional Engineer, Timber Engineering, LLC, Vancouver, Washington, USA, and  
Chairman, Structural Insulated Panel Association Technical Advisory Committee, Fort Lauderdale, Florida, USA

## Introduction

Structural insulated panels (SIPs), as defined in American National Standards Institute/American Plywood Association (ANSI/APA) PRS 610.1 (APA 2018), are strong and energy-efficient construction systems that use the strength of wood structural panels (WSPs) and energy attributes of foam plastic insulation to provide cost-effective solutions for compliance with the governing building codes. However, acceptance of SIPs by many design professionals has been hindered by the lack of a systematic evaluation of their lateral load performance in wall applications. SIP walls are required to bear on the sill plate and use a cap plate (in other words, to be “restrained”), allowing the vertical loads from the story above to be transferred to the story below or to the foundation. It is imperative that the lateral load performance of SIP walls reflects this configuration because this is representative of how SIP walls are constructed in the field. Historically, some SIP walls were evaluated by testing in a manner similar to conventional light-frame walls, i.e., the oriented strandboard (OSB) facers were not allowed to bear on the sill plate and the cap plate (in other words, they were “unrestrained”), and therefore, the actual lateral performance of those SIP walls may not have been realistically characterized.

In a pilot study by APA — The Engineered Wood Association, as documented in APA Report T2010P-17 (APA 2010) and in conjunction with the Structural Insulated Panel Association (SIPA), full-sized SIP walls (two SIP panels 114 mm thick by 1.2 m wide by 2.4 m tall (4.5 in. thick by 4 ft wide by 8 ft tall)) were tested with both monotonic and cyclic loading protocols with the SIP walls constructed to bear on sill plates and be restrained by cap plates. The SIP walls were constructed to have a significantly higher overstrength factor and slightly lower ductility than conventional light-frame walls. These research results led to the inclusion of the lateral load test method specified in ANSI/APA PRS 610.1 for the qualification of SIP walls. To support this test method, the ANSI/APA Standards Committee on ANSI/APA PRS 610.1 recommended that additional research be conducted to generate sufficient data for developing SIP lateral load design values.

This study provides the test data needed to characterize the lateral load performance of SIP walls made of a single panel with full bearing (restrained) at various aspect ratios, SIP walls made of multiple panels without openings, and SIP walls made of multiple panels with various openings. This research program involved lateral testing of 54 full-sized SIP walls of various configurations that encompassed a range of SIP wall configurations commonly used in the field.

All SIP test specimens for this study were supplied from a production run by a SIPA manufacturing member in compliance with International Code Council-Evaluation Service (ICC-ES) code evaluation report ESR-4524. All panels used 11.1-mm (7/16-in.) APA-certified OSB facers with an expanded polystyrene foam core, which not only met the requirements of ANSI/APA PRS 610 but also represented the product under evaluation in this study.

## Background of Previous Research

SIPA has developed product and construction standards, but the basic understanding and lateral performance design of SIP walls constructed with single and multiple panels is evolving. The following will highlight previous studies that led to existing lateral testing and design methods.

### Lateral Testing of SIP Walls

Jamison (1997) tested 2.4- by 2.4-m (8- by 8-ft) SIP wall specimens with various boundary and anchorage detailing. The panels had 11.1-mm (7/16-in.) OSB facing on one side and 12.7-mm (1/2-in.) drywall facing on the other. In that study, 38- by 89-mm (2 by 4) lumber and 12.7-mm (1/2-in.) OSB block spline connections were tested. The tested end-wall boundary conditions included 19- by 89-mm (1 by 4) lumber, 2 by 4 lumber, and 12.7-mm (1/2-in.) OSB surface splines. One configuration also included a double 2 by 4 bottom plate member. Panels were fastened to the perimeter boundary and splice members with 41.2-mm (1-5/8-in.) drywall screws spaced at 152 mm (6 in.) on center and construction adhesive. Specimens were tested monotonically or cyclically without vertical loading, and the



panels were not restrained from rotation by an extended sill plate. Only one of the five configurations included end-wall hold-down anchors. Peak shear loads for the monotonically tested specimens ranged between 4.82 and 12.84 kN/m (330 and 880 lb/ft), with the specimen with hold-down anchors achieving the greatest capacity. Sequential phased displacement cyclic testing of the same configurations resulted in peak shear loads ranging between 4.670 and 12.70 kN/m (320 and 870 lb/ft).

Kermani and Hairstans (2006) evaluated the performance of monotonically loaded 2.4- by 2.4-m (8- by 8-ft) SIP wall systems with and without openings. Opening sizes ranged between 6% and 65% of the wall specimen area.

The wall specimens were constructed with two panels, spliced with a 2 by 4 lumber spline. Fastening of the panels to the perimeter boundary members was achieved with 35-mm-long by 2.64-mm-diameter (1.38-in.-long by 0.104-in.-diameter) screws at 254 mm (10 in.) on center. Each type of wall configuration was tested under two separate conditions: the first condition was without any vertical load applied, and the second was with a 10.22 kN/m (700 lb/ft) gravity load along the top of the specimens. For walls without openings, the peak shear load ranged from 4.67 kN/m (320 lb/ft) for unrestrained walls to 11.38 kN/m (780 lb/ft) for walls restrained with vertical load. For walls with openings, the research confirmed that capacity followed the general trend of the perforated shear wall (PSW) method.

APA (2010) summarized testing of a single 2.4- by 2.4-m (8- by 8-ft) SIP wall configuration subjected to various types of boundary restraints. The tested specimens were constructed with two panels, spliced together with an OSB block spline and attached to the boundary and spline members with 8d common nails spaced at 152 mm (6 in.) on center. The following configurations were tested monotonically: (1) only E72-type hold-downs with facers unrestrained from rotation, (2) E72-type hold-downs and 38- by 140-mm (2 by 6) top and bottom cap plates restraining facer panel edge rotation, and (3) Simpson Strong-Tie (Pleasanton, California, USA) end-wall hold-downs, 2 by 6 cap plates, and additional 46.70 kN/m (3,200 lb/ft) gravity load applied. The respective peak loads were 15.15, 23.09, and 30.94 kN/m (1,038, 1,582, and 2,120 lb/ft) showing that facer bearing and gravity load contributed significantly to the capacity of the wall. Cyclic testing was conducted on walls with only Simpson Strong-Tie hold-downs and 2 by 6 plate caps without gravity load with the walls reaching an average peak load of 17.19 kN/m (1,178 lb/ft), indicating a substantial decrease in capacity caused by the cyclic protocol (however, out of the three tests, at least in two specimens, the failure was at hold-down fasteners or posts and not at the spline as with the monotonic tests).

Mosalam and Günay (2012) investigated the seismic performance of seven SIP walls using both the Consortium

of Universities for Research in Earthquake Engineering (CUREE) protocol and a hybrid simulation with two loading scenarios. They also investigated the effects of nail spacing and gravity effects. In comparison with conventional light-frame construction, SIP walls produced similar load-displacement envelopes but had lower ductility and initial stiffness. Gravity loads led to increased initial stiffness, decreased force capacity, and decreased sliding and gap openings between SIPs. Finally, the CUREE protocol was too conservative compared with the hybrid simulation and, as with light-frame walls, near-fault pulse-type ground motions were more critical and damaging.

Terentiuk and Memari (2012) evaluated the seismic performance of both SIP and wood-frame panels. In total, 21 2.4- by 2.4-m (8- by 8-ft) shear walls were tested, 5 via monotonic loading and 16 with a CUREE loading protocol. Investigated parameters included fastener type, spline design, hold-down location, and direct bearing. They concluded that fastener type had the greatest effect on the lateral performance of SIPs and that 8d common nails used to connect framing to sheathing were the most effective fastener type. Using these data, Donovan and Memari (2015) attempted to determine the seismic performance factors (SPF) for SIPs. They used the archetype developed in the Federal Emergency Management Agency (FEMA ) P695 (FEMA 2009) wood examples along with the data generated by Terentiuk and Memari (2012) for a 2.4- by 2.4-m (8- by 8-ft) SIP wall containing an OSB spline with a 152-mm (6-in.) 8d common fastening schedule to conduct a limited P695 analysis for four archetypes. Donovan and Memari (2015) concluded that an R value of 6 was optimistic based on the performance of three of the four building models, but more extensive experimental testing will be needed to support the SPF generated from their work.

Kochkin and others (2015) conducted an experimental study to evaluate the lateral resistance performance of high-aspect-ratio SIP shear wall segments and SIP shear walls with window and door openings. At most, two replicates of fully anchored SIP shear walls were cyclically tested at the following aspect ratios: 1:1, 2:1, 3:1, and 4:1. Five additional tests were conducted with multiple SIP wall panels that contained door and window openings of various sizes. All SIP panels were fastened to the framing using 8d nails with a 102-mm (4-in.) spacing. Based on the experiments, the unit stiffness of the SIP shear wall varied by aspect ratio and the unit shear capacity decreased with increasing aspect ratio. Spline joints between wall segments also decreased capacity. Finally, test results indicated that multiple-segment SIP shear walls with openings followed the overall trend predicted by the PSW method for both strength and stiffness.

Yeh and others (2018) characterized the lateral load performance of SIP walls with full bearing (restrained). The



research program involved structural testing of 29 2.4- by 2.4-m (8- by 8-ft) SIP walls of various configurations that bracketed a range of SIP wall configurations commonly used in the field. Only restrained configurations were tested in the project and were compared with unrestrained configurations tested previously (APA 2010). Results indicated that the cyclic performance parameters for all walls tested in this study met the overstrength and ductility capacities of ICC-ES AC04 (ICC-ES 2015), although some walls had drift capacities slightly lower than the AC04 criterion. The one exception was the SIP wall without any vertical joints, which showed a significantly lower drift capacity. Overall, Yeh and others (2018) investigated testing protocol, nail size, nail spacing, spline type, SIP thickness, and bottom plate washer geometry.

### Shear Wall Design

Since the 1994 Northridge earthquake, the performance of walls under seismic loading and improving shear wall design tools have been concerns of the wood industry. Three methodologies for shear wall design are provided in the American Wood Council (AWC) Special Design Provisions for Wind and Seismic (SDPWS-2015) (AWC 2015): the segmented shear wall, perforated shear wall, and force transfer around openings (FTAO) methods. The segmented shear wall methodology assumes that only the full-height sections or segments, which have hold-downs on each segment end, resist the lateral forces. Resistance of each full-height segment is summed together to determine resistance of the entire length of the shear wall. Resulting resistance is generally considered to be a conservative estimate.

Testing conducted by Yasumura and Sugiyama (1984) studied one-third scale monotonic racking tests of wood stud, plywood-sheathed shear walls with openings. The researchers defined the sheathing ratio,  $r$ , to classify walls based on the amount of openings:

$$r = \frac{1}{1 + \left( A_o / H \sum_o^i L_i \right)}$$

where  $A_o$  is the total area of openings,

$H$  is the height of the wall, and

$\sum L_i$  is the summation of length of a full-height wall segment.

Sugiyama and Matsumoto (1994) determined an empirical equation to relate shear capacity and sheathing area ratio based on scaled tests. Their empirical equation related the ratio,  $F$ , of the shear load for a wall with openings to the shear load of a fully sheathed wall at shear deformation angle of 1/100 radians for ultimate capacity.

$$F = \frac{r}{3 - 2r}$$

This method was referred to as the PSW method. The method has since been adopted into the design provisions for wood shear walls published by the AWC (SDPWS-2015) and referenced in model building codes.

### Objective

The research for this study established the test data needed to characterize the lateral load performance of SIP walls with full bearing on a sill plate and a cap plate (restrained) under cyclic loading. The research program involved structural testing of 54 full-sized SIP walls of various configurations that bracketed a range of SIP wall configurations commonly used in the field. Single wall configurations were evaluated with and without hold-downs. All test wall configurations were restrained against panel rotation by the sill plate, which was slightly wider than the width of the SIP panel. The SIP wall variables examined are shown in the following list:

- Walls constructed with a single SIP, aspect ratios of 1:1, 2:1, 3:1, and 4:1, with and without hold-downs
- Walls constructed with multiple 1.2- by 2.4-m (4- by 8-ft) SIPs for walls up to 6.0 m (20 ft) in length without openings
- Walls constructed with multiple SIPs and various configurations for 6.0-m- (20-ft-) long walls with various openings

The results obtained from this testing were intended to provide engineering information for the design of SIP walls as lateral load resisting systems for all regions of the United States.

## Experimental Procedures

### Specimen Configurations

Although the research project can be broken into three distinct configuration features, all specimens were 2.4-m (8-ft) tall and constructed with common attributes. The nailing schedule, end-posts, hold-downs, and spline configurations were consistent across all specimens. Common features will be discussed followed by details specific to each of the three distinct configurations. Table 1 lists the common construction details, and Table 2 lists the fastening schedules for all the constructed walls. Figure 1 shows the general construction details consistent for all of the constructed single- and multiple-panel walls.

All let-in framing members consisted of No. 2 or better spruce–pine–fir 2 by 6 lumber. The framing was inserted into the foam core between the OSB facings of the SIP panel and attached with 8d box nails at 152-mm (6-in.) on-center spacing. Single framing members were used for top and bottom plates. Double stud posts were used at wall ends to accommodate the attaching of the hold-downs and

**Table 1—Common construction details for all walls**

Item	Detail
Wall height	2.4 m (8 ft)
Wall panels	165-mm- (6.5-in.-) thick structural insulated panels with oriented strandboard facers 11.1 mm (7/16 in.) thick with an expanded polystyrene foam core
Framing lumber	38- by 140-mm (2 by 6) spruce–pine–fir #2 grade
Sill plate	38- by 184-mm (2 by 8) spruce–pine–fir #2 grade
Framing fastening	10d pneumatic (82.6- by 3.33-mm) nails with full round head
Sheathing fastening	8d pneumatic (60.3- by 2.87-mm) nails with full round head
Anchor bolts	12.4-mm ASTM A307 bolts (standard round washer)
Hold-downs	Simpson Strong-Tie HDU5 fastened with 14 SDS25212 screws

**Table 2—Fastening schedules for all constructed walls**

Item	Fastening schedule	Detail
Panel sheathing to frame	60.3- by 2.87-mm nail	152 mm (6 in.) on center
Panel sheathing to spline	60.3- by 2.87-mm nail	152 mm (6 in.) on center
Bottom plate to sill plate	76.0- by 3.33-mm nail	203 mm (8 in.) on center
Top plate to stud	88.9- by 4.11-mm nail	End nailed (two nails)
Bottom plate to stud	88.9- by 4.11-mm nail	Toe nailed (two nails)
End posts (two 2 by 6)	82.6- by 3.33-mm nail	406 mm (16 in.) on center
Loading beam to top plates	15.9- by 203-mm lag screw	152 mm (6 in.) on center
	15.9- by 203-mm lag screw	457 mm (18 in.) on center <sup>a</sup>

<sup>a</sup>Spacing for 6.1-m specimens.

were nailed together using two 16d pneumatic nails every 406 mm (16 in.). Additionally, No. 2 or better spruce–pine–fir 38- by 184-mm (2 by 8) cap and sill plate members were attached to top and bottom let-in framing using two 10d (3.33- by 76-mm) nails spaced 204 mm (8 in.) on center. These cap and sill plate members were slightly wider than the SIP panel, allowing the OSB to bear directly for the purpose of transferring vertical loads.

Between the end-posts, sill plates were secured to the 254- by 254- by 12.5-mm (10- by 10- by 1/2-in.) hollow structural section with 12.4-mm (1/2-in.) American Society for Testing and Materials (ASTM) A307 (ASTM 2019a) bolts and a standard round washer. Hold-downs consisted of Simpson Strong-Tie HDU5 fastened with all 14 SDS25212 screws to secure it to the end-post. Each wall specimen or section of wall was constructed on the laboratory floor adjacent to the test setup and lifted in place with a crane using the transfer beam.

### Walls Constructed with Single SIPs

To evaluate the effects of panel aspect ratio on lateral capacity, four lengths of panels (2.4, 1.2, 0.8, and 0.6 m (8, 4, 2.6, 2 ft)) were tested with and without hold-downs (Fig. 2). These lengths represent 1:1, 2:1, 3:1, and 4:1 wall length to height ratios. The test matrix is shown in Table 3. For the 1:1 and 2:1 single-panel tests, the inner spacing of the anchor bolts, with round washers, was 0.6 m (2 ft), but

for the 3:1 and 4:1 single-panel tests, the inner spacing was decreased to 0.2 m (8 in.). Unique to this testing was the attachment of the hold-downs on the inside of the double end-post for the 2:1, 3:1, and 4:1 tests. Hold-downs are the main component that resists the uplift of the panel, and therefore, placement of the hold-down on the exterior side of the double end-post for experimental ease can lead to greater test resistance. Hold-downs were attached to the double end-posts prior to nailing them to the SIP panel, and to facilitate attachment of the hold-down to the test base, the hold-down and bolt heads were tack-welded to allow the nuts to be tightened according to ASTM E564 (ASTM 2014a) standard torque.

### Walls Constructed with Multiple SIPs without Openings

Most SIP wall lines are constructed with a series of interconnected individual panels. Three multiple-panel walls of varying total length (2.4, 3.6, and 6 m (8, 12, 20 ft)) using a block spline configuration were evaluated (Figs. 3 and 4). Each 1.2- by 2.4-m (4- by 8-ft) single panel for all the multiple-panel specimens contained two anchor bolts. The let-in framing and cap plate or sill plate framing were continuous across all spline joints. Butt joints were staggered to avoid introducing a vulnerability at the same location. Hold-downs were only placed at the end

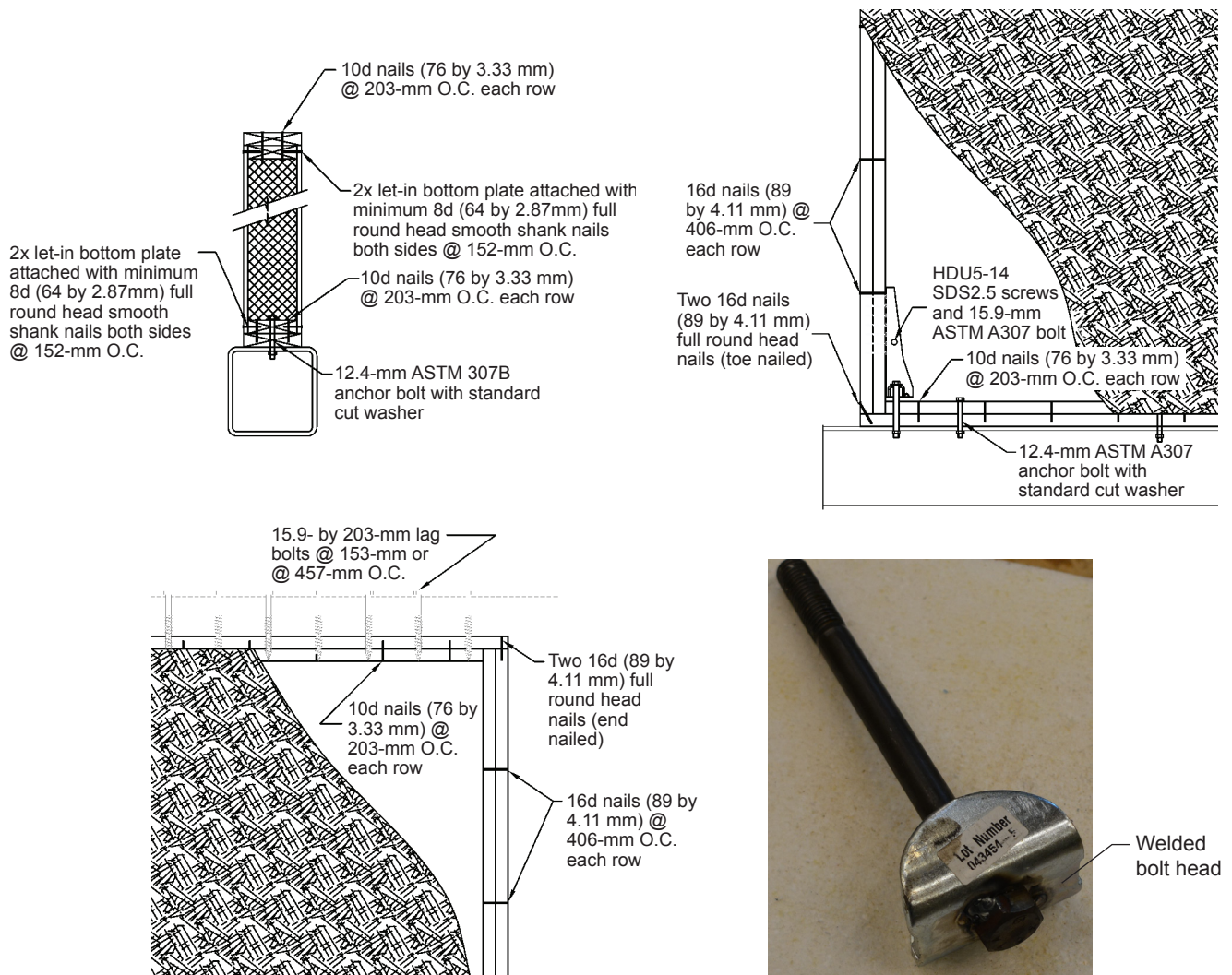

Figure 1. Construction details for all SIP wall configurations.

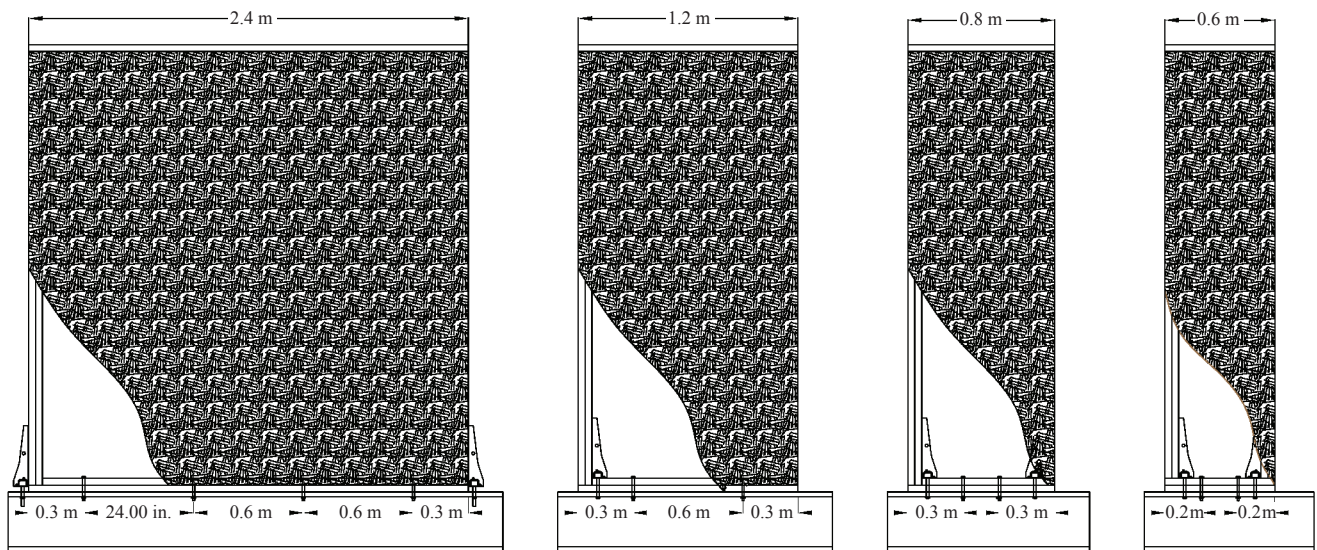

Figure 2. Wall configuration for single-panel SIP wall tests with and without hold-downs.



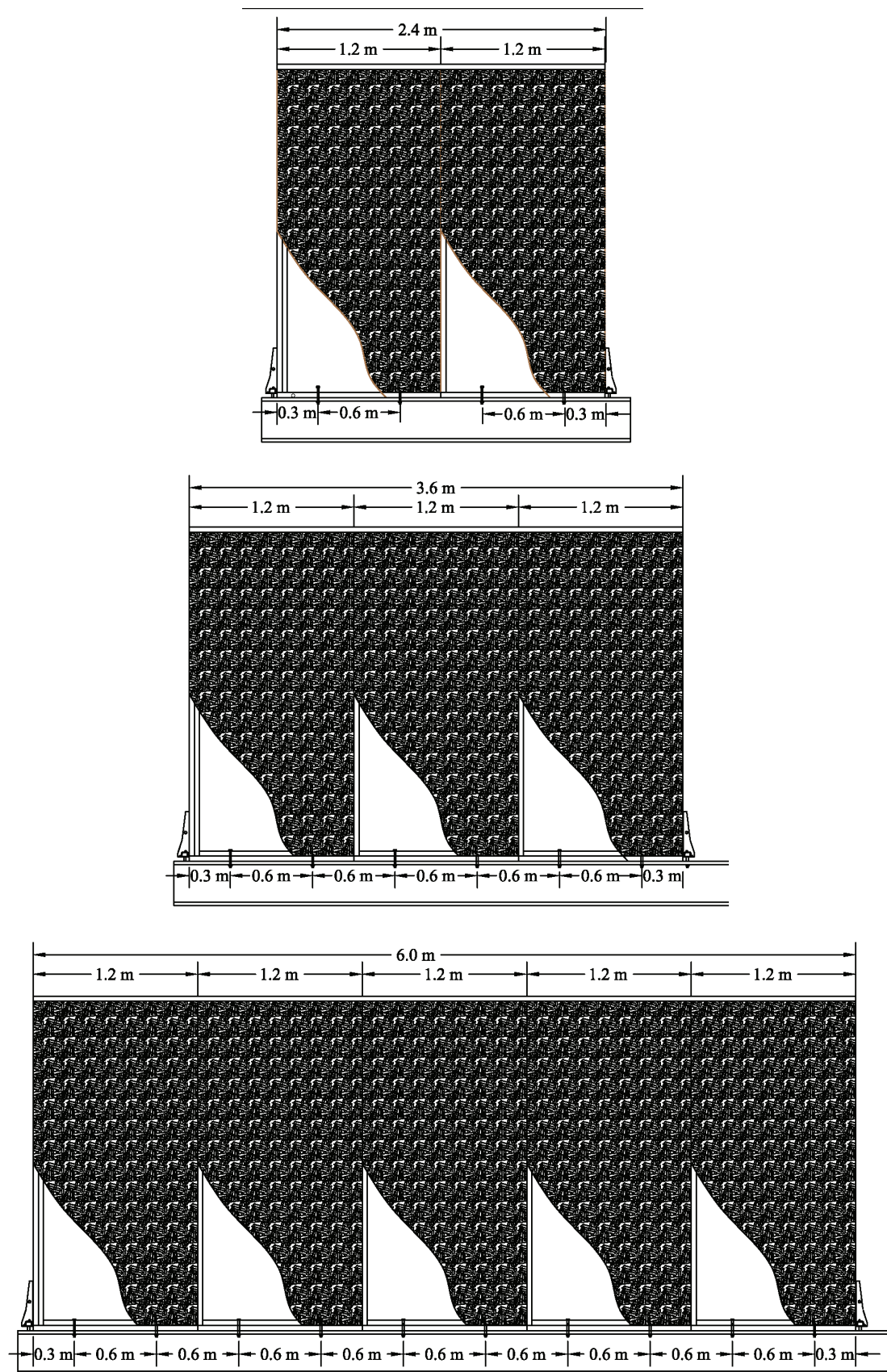
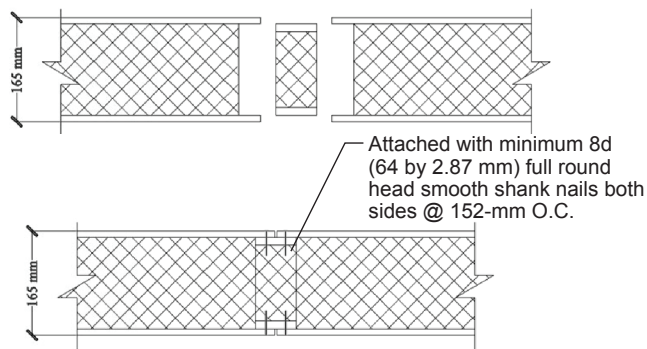

Figure 3. Configurations for multiple-panel SIP walls without openings.



**Figure 4. Block spline detail.**

of the wall, on the outside of the double end-posts. For all multiple-panel specimens, panel joints were constructed using block splines in accordance with Figure 4. The spline was full height and 140 mm (5.5 in.) deep and was attached using 2.87- by 63.5-mm (0.113- by 2.5-in.) nails spaced 152 mm (6 in.) on center.

### Walls Constructed with Multiple SIPs with Openings

Seven different wall configurations, all 6.0 m (20 ft) in length, were used to evaluate the effect of openings on lateral resistance. All wall openings were representative of human passage or garage doors. Walls were constructed with 1.2- or 2.4-m- (4- or 8-ft-) long full-height panels and 0.44-m- (18-in.-) tall SIP headers of varying lengths. Figure 5 shows the seven configurations of walls constructed with multiple SIPs with openings. Two anchor bolts were used to attach each 2.4-m (8-ft) panel, and only one anchor bolt was used for a 1.2-m (4-ft) panel. Panel joints consisted of the block spline configuration highlighted in the previous section. SIP panel and headers were attached as shown in Figure 6. A short single let-in 2 by 6 jack stud was incorporated in the panel. The header let-in sill plate rested on the top of the jack stud. A block spline detail was used to attach the panel and header. The let-in, top framing, and bottom framing were continuous spline joints, but to avoid introducing vulnerabilities at the splices, butt joints of the let-in and top or bottom framing were staggered. Hold-downs were only placed at the end of the wall on the outside of the double end-posts. For each wall configuration, three replicates were tested.

### Testing Procedures

Testing was conducted in accordance with provisions of ASTM E2126-11 (ASTM 2014b). All walls were tested by displacing the top of the specimen in accordance with the CUREE cyclic protocol (Method C, ASTM E2126-11) at a constant frequency of motion for a given reference deformation as shown in Figure 7. The reference deformation ( $\Delta$ ) for the cyclic CUREE protocol was estimated from previous SIP studies and was varied for the single-panel tests with differing aspect ratios (Table 3).

For all multiple-panel tests, a reference deformation of constant 50.4 mm (2.0 in.) was used in accordance with ASTM E2126-11 Test Method C. Figure 8 shows the testing configuration for single- and multiple-panel SIP specimens. Load was applied with an MTS hydraulic actuator (MTS Systems Corporation, Eden Prairie, Minnesota, USA) with a total stroke of 508 mm (20 in.) and a maximum excursion limit of 248 mm (9.75 in.). This actuator applied the deformation through a 76- by 127- by 6.4-mm (3- by 5- by 0.25-in.) walled steel distribution beam (moment of inertia of  $EI = 66,195.1 \text{ kg m}^2$  (226,200,000 lb-in<sup>2</sup>)) lag-bolted through a 2 by 8 top plate and a 2 by 6 lower top plate with 15.9-mm- (5/8-in.-) diameter, 203-mm- (8-in.-) long bolts spaced every 102 mm (6 in.) for walls less than 2.4 m (8 ft) in length and spaced every 204 mm (12-in.) otherwise. Out-of-plane deformations were restrained by a set of rollers located on the side of the load beam.

The load was measured using an electronic load cell, with a capacity of 245 kN (55,000 lb) located between the cylinder and the steel distribution beam. Deformations were measured using a linear variable differential transformer (LVDT) or linear potentiometer, whereas hold-down loads were measured with low profile 89-kN (20,000-lb) Honeywell (Charlotte, North Carolina, USA) load cells. A total list of experimental measurements follows:

1. Displacement of the actuator
2. Displacement of the top plate relative to the setup base, opposite the applied load
3. Bottom plate slip relative to the setup base
4. Compression and uplift at the specimen corner stud relative to the setup base
5. Force applied to top of wall
6. Hold-down forces, measured with load cells.

The lateral loading testing apparatus was controlled via a computer-based system, and a minimum sampling rate of 40 Hz was used such that at least 175 data points were recorded for each cycle.

## Results

This section summarizes results of testing and presents a limited analysis for the performance of single walls with and without hold-downs, walls without openings, and walls with openings. In accordance with ASTM E2126-11, performance parameters for all cyclic tests were derived as an arithmetic average of the positive and negative envelope curves. The reported performance parameters include peak load, unit shear, shear stiffness at 0.4 peak load, unit shear stiffness at 0.4 peak load, and deflection at peak load. Table 4 summarizes the results for single-panel varying aspect ratio tests with hold-downs. Table 5 summarizes the results for single-panel varying aspect ratio tests without

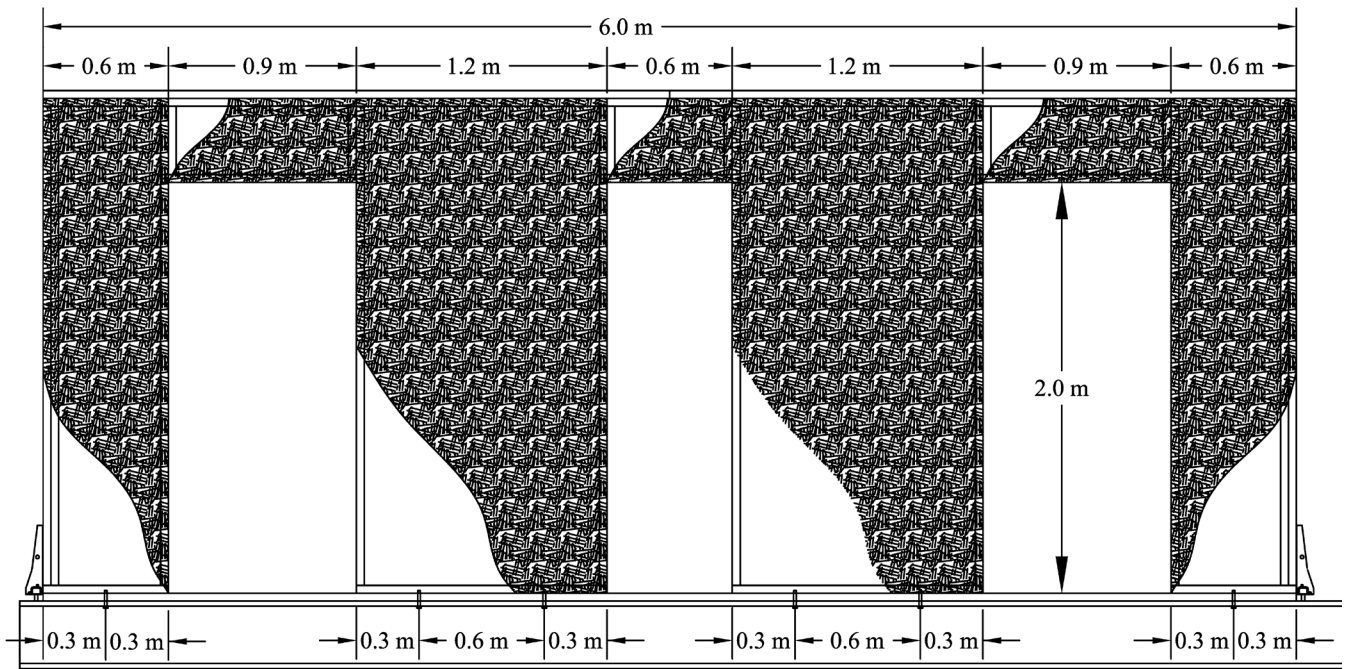

**Configuration 1**

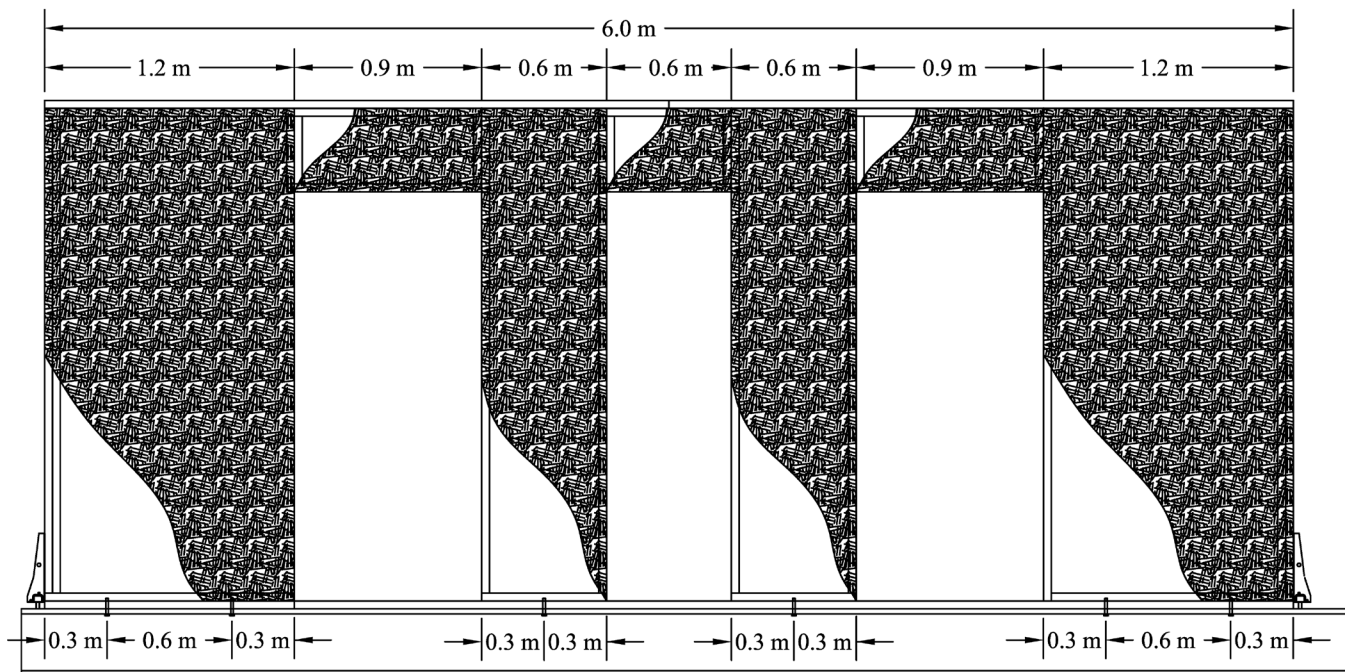

**Configuration 2**



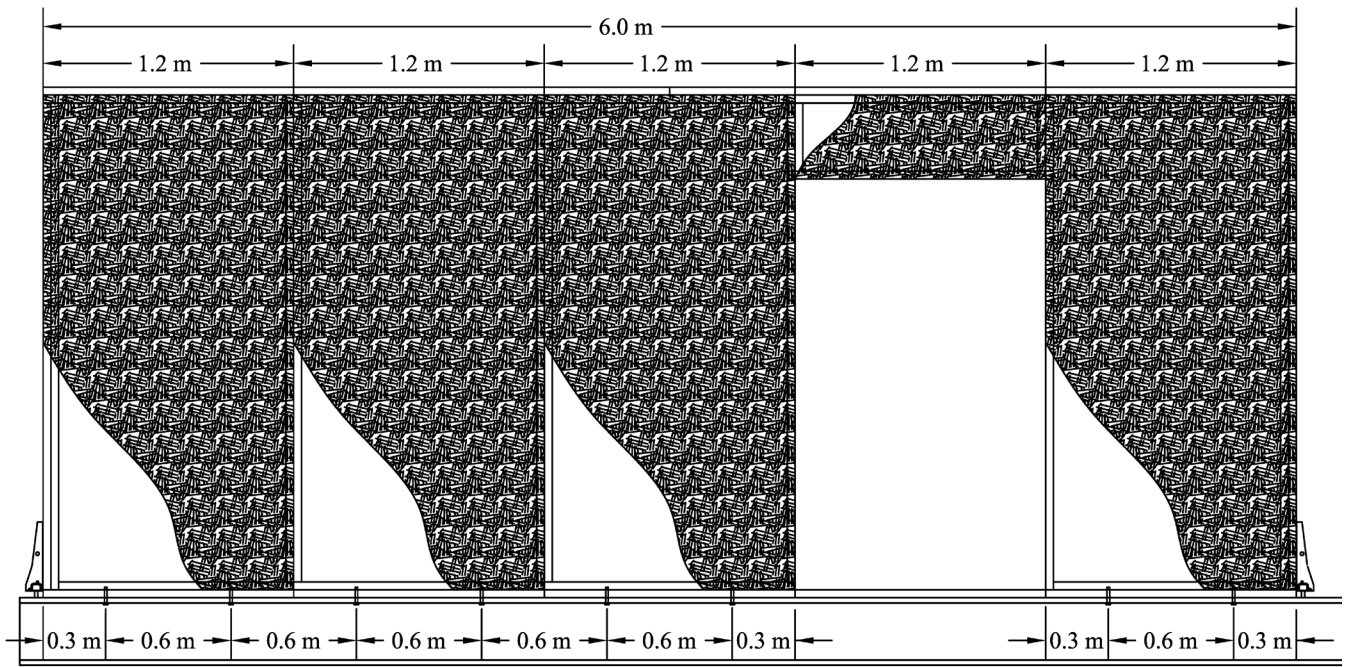

**Configuration 3**

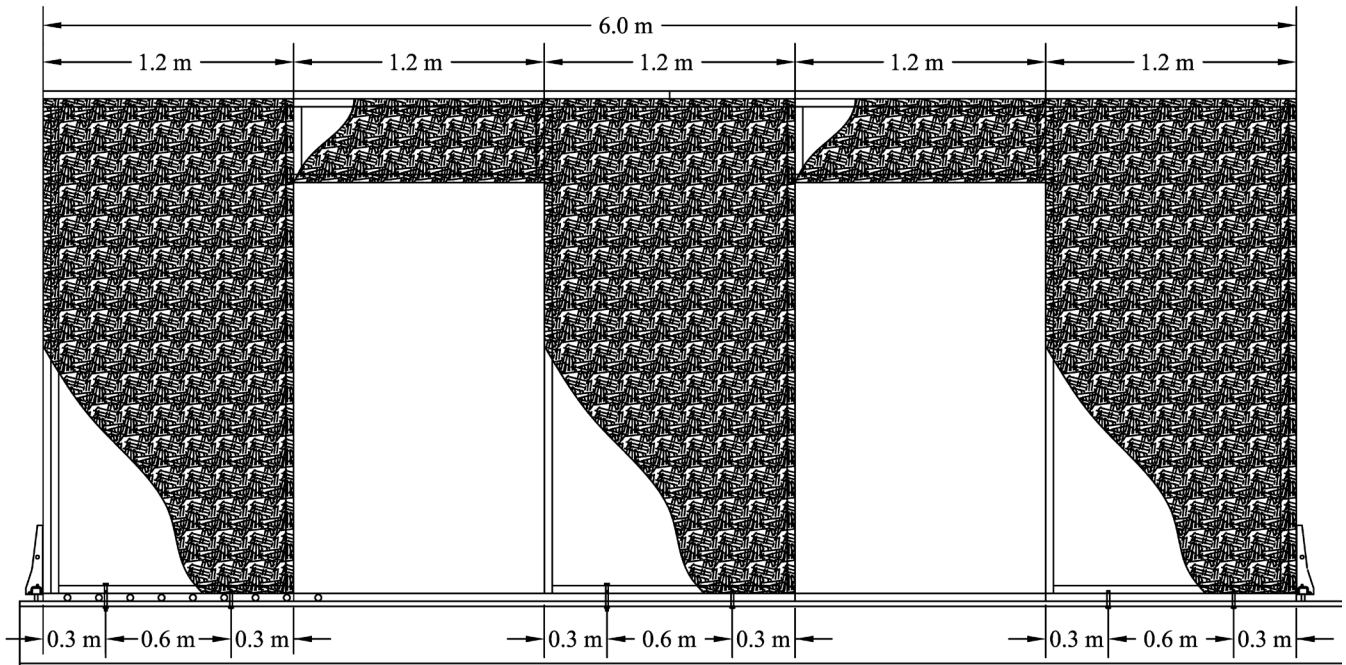

**Configuration 4**

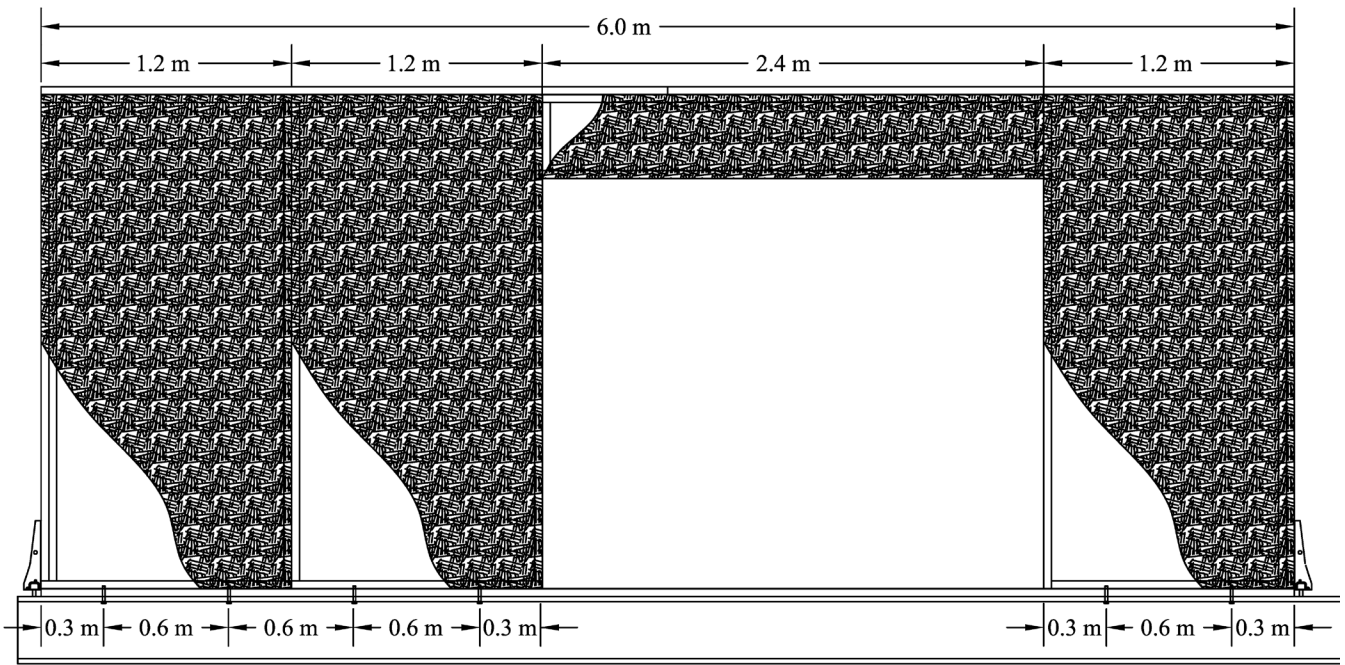

**Configuration 5**

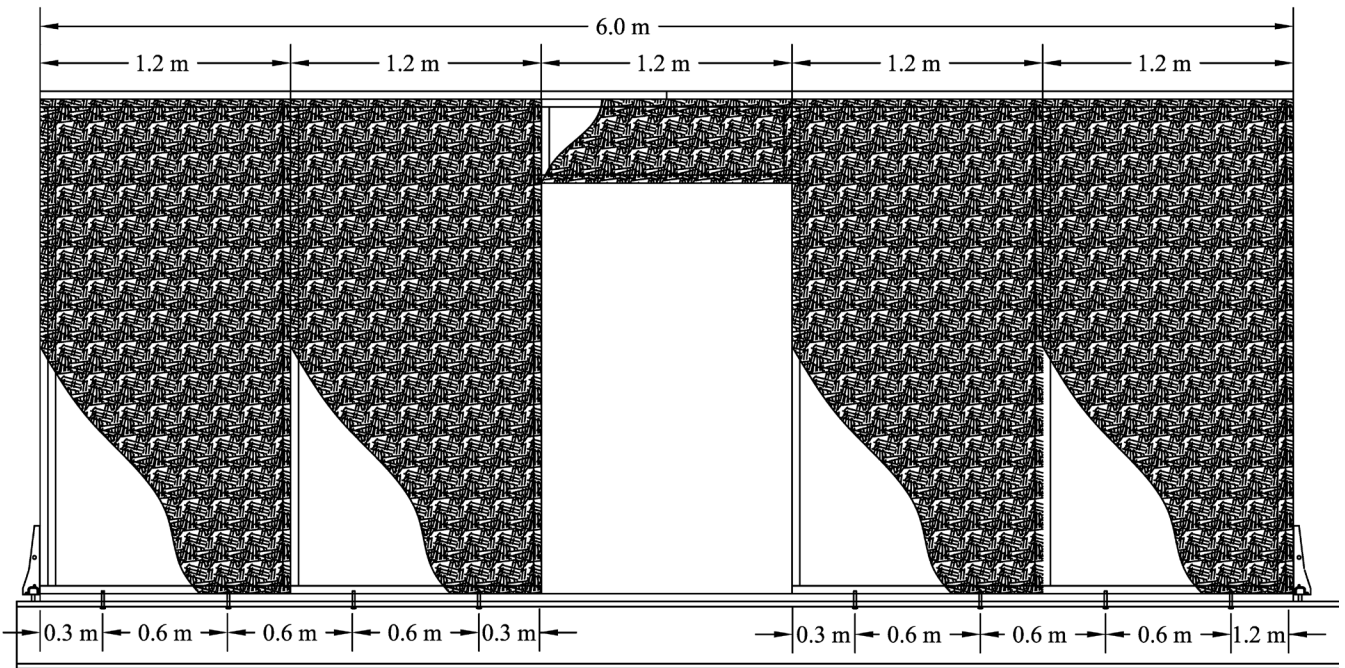

**Configuration 6**



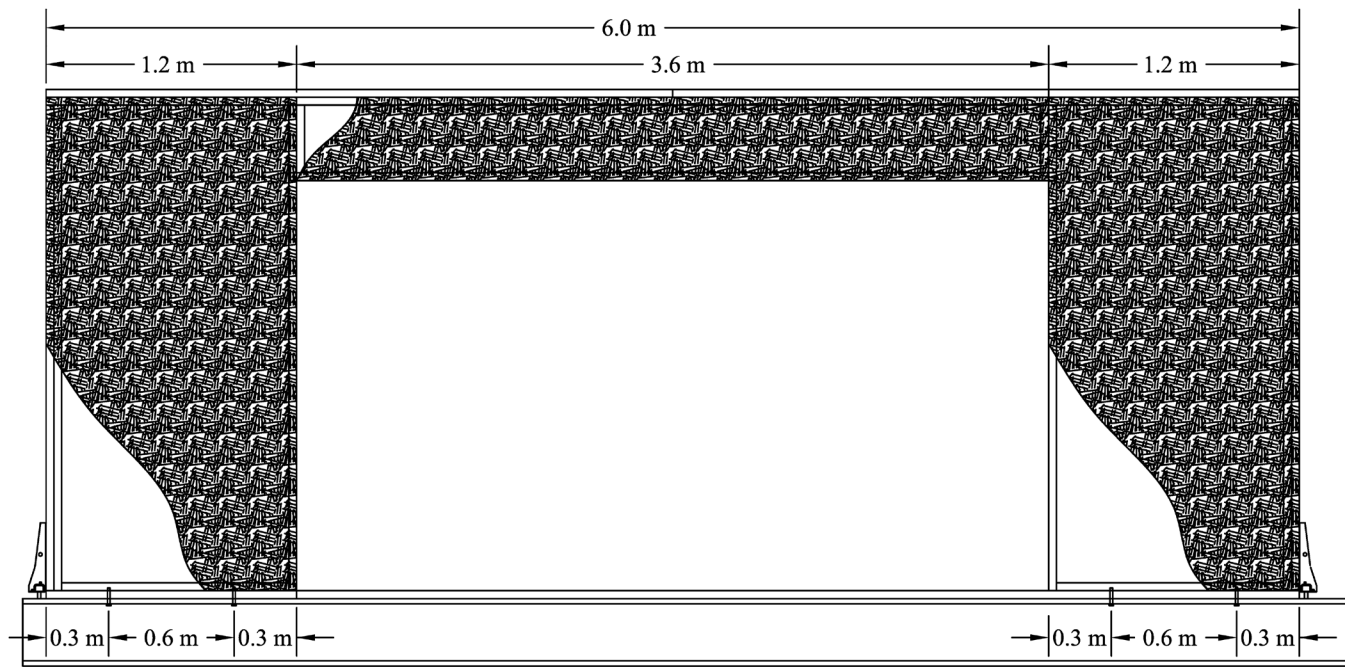

**Configuration 7**

**Figure 5. Configurations for multiple-panel SIP walls with openings.**

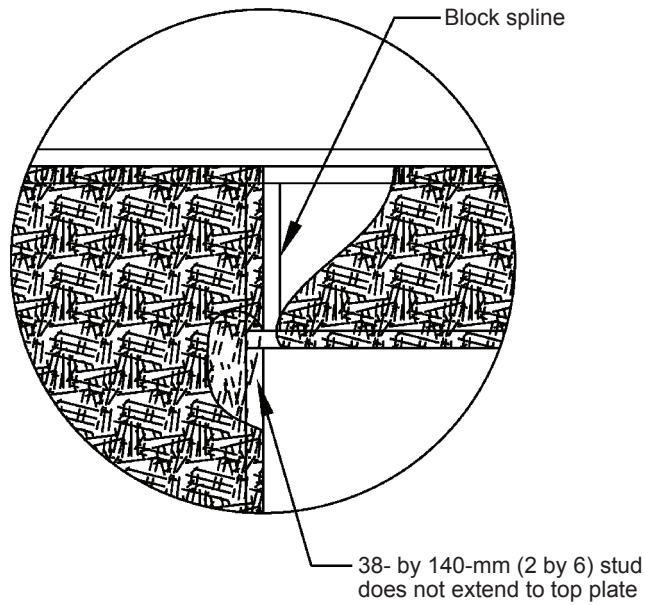

**Figure 6. SIP panel to header detail.**

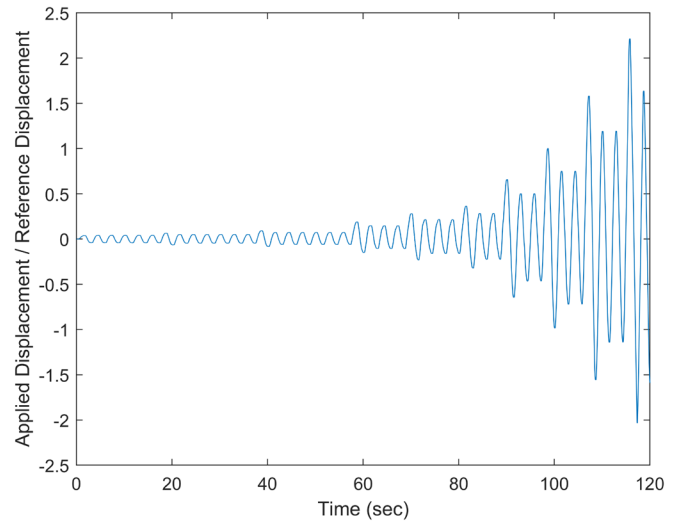

**Figure 7. ASTM E2126 Method C loading protocol for a reference deformation.**



**Table 3—Test matrix for single-panel wall configuration**

SIP configuration	Aspect ratio	Hold-downs		No hold-downs	
		Cyclic rate (Hz)	Reference deformation (mm)	Cyclic rate (Hz)	Reference deformation (mm)
2.4 by 2.4 m	1:1	0.35 <sup>a</sup>	50.8	0.35 <sup>a</sup>	50.8
1.2 by 2.4 m	2:1	0.20	50.8	0.20	50.8
0.8 by 2.4 m	3:1	0.20 <sup>b</sup>	63.5	0.20	63.5
0.6 by 2.4 m	4:1	0.20	76.2	0.20	76.2

<sup>a</sup>One wall tested at a rate of 0.20 Hz.

<sup>b</sup>One wall tested at a rate of 0.35 Hz.



Figure 8. Testing configuration for single- and multiple-panel SIP specimens.

**Table 4—Summary of experimental results for single-panel SIP walls with various aspect ratios with hold-downs**

Aspect ratio	Specimen number	$P_{peak}$ (kN)	$P_{peak}/L_{wall}$ (kN/m)	$K_{0.4P}$ (N/mm)	$K_{0.4P}/L_{wall}$ (N/mm/m)	$\Delta_{peak}$ (mm)
1:1	1	43.56	17.86	3,373	1,383	41.4
	2	48.73	19.99	1,524	625	69.7
	3	48.05	19.70	3,901	1,600	46.2
	Average	46.78	19.18	2,933	1,203	52.4
2:1	1	20.23	16.59	552	453	64.0
	2	21.59	17.71	850	697	73.5
	3	21.30	17.47	707	580	77.1
	Average	20.91	17.15	703	577	68.7
3:1	1	13.03	16.04	229	281	96.5
	2	13.87	17.07	298	367	127.9
	3	12.64	15.55	177	217	125.7
	Average	13.18	16.22	235	289	116.7
4:1	1	9.70	15.92	124	204	151.1
	2 <sup>a</sup>					
	3	9.88	16.21	158	259	149.1
	Average	9.79	16.06	141	231	150.1

<sup>a</sup>Initial misalignment caused pulse displacement in first cycle, which led to unbalanced cyclic loading. Data not included in tables.

**Table 5—Summary of experimental results for single-panel SIP walls with various aspect ratios without hold-downs**

Aspect ratio	Specimen number	$P_{\text{peak}}$ (kN)	$P_{\text{peak}}/L_{\text{wall}}$ (kN/m)	$K_{0.4P}$ (N/mm)	$K_{0.4P}/L_{\text{wall}}$ (N/mm/m)	$\Delta_{\text{peak}}$ (mm)
1:1	1	15.75	6.46	3,366	1,380	35.7
	2	14.10	5.78	2,496	1,023	20.0
	3 <sup>a</sup>					
	Average	14.93	6.12	2,931	1,202	27.9
2:1	1	6.27	5.14	395	324	71.6
	2	5.56	4.56	879	721	27.6
	3	5.77	4.73	448	367	42.8
	Average	5.86	4.81	502	471	47.3
3:1	1	3.62	4.46	127	157	85.2
	2	3.27	4.02	148	182	46.7
	3	3.36	4.13	205	252	63.0
	Average	3.42	4.20	160	197	65.0
4:1	1	3.92	6.43	88	145	132.9
	2	1.97	3.23	158	260	32.9
	3	2.49	4.09	123	202	79.8
	Average	2.79	4.58	109	202	81.8

<sup>a</sup>SIP sheathing contacted top of wall potentiometer attachment in push cycle, and incorrect displacement was measured. Data excluded from table.

**Table 6—Summary of experimental results for multiple-panel SIP walls without openings**

No. of panels	Specimen number	$P_{\text{peak}}$ (kN)	$P_{\text{peak}}/L_{\text{wall}}$ (kN/m)	$K_{0.4P}$ (N/mm)	$K_{0.4P}/L_{\text{wall}}$ (N/mm/m)	$\Delta_{\text{peak}}$ (mm)
2	1	42.03	17.24	3,024	1,240	39.4
	2	39.67	16.27	2,459	1,009	44.0
	3	40.08	16.44	2,324	953	49.3
	Average	40.59	16.65	2,602	1,067	44.2
3	1	60.03	16.41	3,545	969	48.8
	2	54.48	14.89	4,448	1,216	41.7
	3 <sup>a</sup>					
	Average	57.25	15.65	3,924	1,093	45.3
5	1	87.41	14.34	4,668	766	47.4
	2	88.51	14.52	6,163	1,011	60.2
	3	93.55	15.35	6,181	1,014	59.7
	Average	89.82	14.73	5,671	930	55.8

<sup>a</sup>Data for Specimen 3 were accidentally compromised and were therefore not included.

**Table 7—Summary of experimental results for multiple-panel SIP walls with openings**





Configuration		Specimen number	$P_{peak}$ (kN)	$P_{peak}/L_{wall}$ (kN/m)	$K_{0.4P}$ (N/mm)	$K_{0.4P}/L_{wall}$ (N/mm/m)	$\Delta_{peak}$ (mm)
201		1	35.06	5.75	2,595	426	44.9
		2	34.58	5.67	2,628	431	45.7
		3	36.38	5.97	2,595	426	45.0
		Average	35.34	5.80	2,605	427	45.2
202		1	48.65	7.98	2,745	450	60.1
		2	42.42	6.96	2,720	446	41.2
		3	46.33	7.60	2,330	382	46.4
		Average	45.80	7.51	2,583	426	49.2
203		1	64.64	10.60	3,956	649	39.5
		2	69.08	11.33	6,622	1,086	38.3
		3	65.56	10.76	5,341	876	38.9
		Average	66.43	10.90	5,104	870	38.9
204		1	43.69	7.17	2,804	460	40.1
		2	43.73	7.17	3,021	496	38.0
		3	46.84	7.68	3,162	519	30.0
		Average	44.75	7.34	2,992	491	36.0
205		1	49.24	8.08	3,169	520	35.7
		2	49.64	8.14	4,816	790	31.5
		3	50.64	8.31	4,046	664	39.3
		Average	49.84	8.18	3,897	658	35.5
206		1	63.90	10.48	5,063	831	38.2
		2	70.55	11.57	4,912	806	43.9
		3	61.86	10.15	5,757	944	29.4
		Average	65.44	10.73	5,203	860	37.2
207		1	33.97	5.57	2,127	349	40.8
		2	31.90	5.23	2,034	334	37.4
		3	33.86	5.55	1,848	303	34.1
		Average	33.25	5.45	2,003	329	37.4



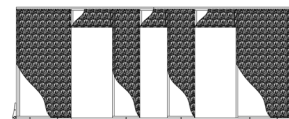

Figure 9. Failure modes for single-panel SIP tests.

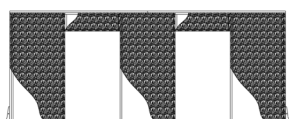
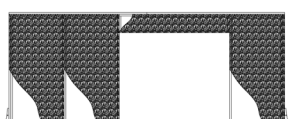
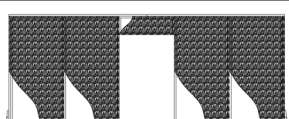
hold-downs. Table 6 summarizes the results for SIP walls constructed without openings. Table 7 summarizes the results for SIP walls constructed with openings.

## Observations and Failures

The following section will highlight general observations of the SIP wall configurations. Appendix A contains tables of notes and failure descriptions for all tested SIP wall configurations.

### Walls Constructed with Single SIPs

For all the single SIP walls with hold-downs, the ultimate mode was the failure of the connection between the let-in framing and OSB panel (Fig. 9). For the 1:1 and 2:1 aspect ratio walls with hold-downs, the walls both slid and rocked during loading, whereas only rocking was observed for the 3:1 and 4:1 aspect ratio walls. Compared with the panels with hold-downs, panels without hold-downs had more failures between the bottom let-in framing and the OSB panel or simultaneous failures at the top and bottom let-in framing and panel. Some let-in framing failed because of cross grain bending. Both the video and graphs of panel uplift showed that the addition of hold-downs significantly decreased the uplift of the end-post and provided an additional load path.

### Walls Constructed with Multiple SIPs without Openings

As with the single-panel tests with hold-downs, all the multiple-panel tests with no openings ultimately failed because the connection between the top let-in framing and the OSB could no longer transfer the loading (Fig. 10). During the test, sliding of the entire wall systems was observed, whereas the individual panels exhibited a rocking behavior. Because of the rocking of the individual panels, the top and bottom corners of adjacent SIP panels exhibited localized crushing. Figure 10 shows typical failures seen for the multiple-panel SIP walls without openings.



Figure 10. Failure modes for multiple-panel SIP wall without openings.





Figure 11. Failure modes for multiple-panel SIP walls with openings.

### Walls Constructed with Multiple SIPs with Openings

It was difficult to visually determine precisely when the multiple-panel SIP walls with openings failed, but in general, the connection of the SIP header to the full-size SIP typically weakened and broke first. Depending on the configuration, the continuous built-up top let-in framing and cap plate continued to transfer load to the remaining full-size panels. Upon continued loading, the full-size panels continued to resist applied load via rocking. This led to loosening of the panel-to-panel connection, but the final failure was the let-in framing to panel connection at the top or bottom of the remaining SIP wall. Figure 11 shows

typical failures seen for the multiple-panel SIP walls with openings.

## Discussion

### Equivalent Energy Elastic–Plastic Curve Parameters

Because of the difficulty in identifying the precise yield strength of the nonlinear SIP resistance deformation response, the equivalent energy elastic–plastic (EEEP) model was used to develop design parameters as shown in Figure 12. The model assumes the energy dissipated

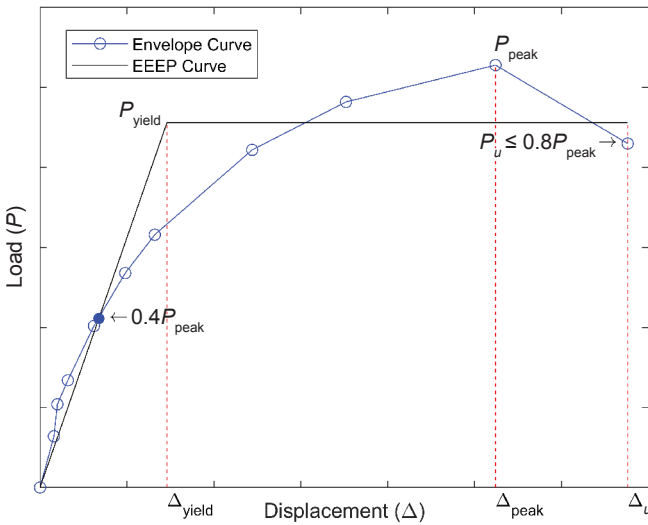

**Figure 12. Equivalent energy elastic-plastic (EEEE) curve and parameters.**

by the test wall during the reversed cyclic loading is equivalent to the energy found under the corresponding bilinear elastic-plastic curve. Only the backbone curve of the reversed cyclic test data was used in the EEE model energy calculations. These parameters included  $\Delta_{yield}$ , displacement at  $P_{yield}$ ,  $\Delta_{peak}$ , displacement at  $P_{peak}$ ,  $P_u$ , and load corresponding to the failure limit. The EEE model approach was used on all the single- and multiple-panel SIP wall cyclic test data. From the backbone curve,  $P_{peak}$ , the maximum absolute load resisted by the specimen and ultimate displacement,  $\Delta_u$ , were determined. Using these values, the yield load,  $P_{yield}$ , can be determined by the following expression:

$$P_{yield} = \left( \Delta_u - \sqrt{\Delta_u^2 - \frac{2A}{K_e}} \right) K_e$$

where  $A$  is the area under the backbone curve to  $\Delta_u$ ,

$K_e = 0.4P_{peak}/\Delta_e$ , and

$\Delta_e$  is displacement at  $0.4 P_{peak}$ .

The EEE parameters were determined for the positive and negative quadrant of the respective data. Tables 8 to 10 list the average for each configuration. Appendix B provides the EEE parameter tables and graphs that contain the cycle data with both the backbone and EEE curve overlaid for all tests.

## Hysteretic Models

Since the acceptance of FEMA P695 as the method to determine seismic design parameters, more emphasis has been placed on the analysis of structures via nonlinear time history analysis programs. Structural analysis programs developed for timber structures, such as SAWS and SAPWood, need hysteretic wall behavior data to simulate structural behavior under seismic events. Two hysteretic models have been developed for wood wall behavior: the

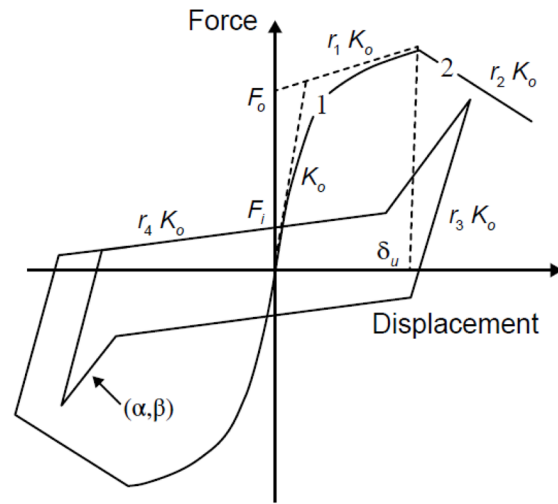

**Figure 13. Modified Stewart hysteretic model and associated parameters.**

modified Stewart and the evolution damage parameter models (Pang and others 2007). For all tested walls, the modified Stewart model was fit to the experimental data. The modified Stewart model uses 10 parameters, highlighted in Figure 13, to describe the hysteretic behavior of the structural panel.

A MATLAB (Mathworks Inc., Natick, Massachusetts, USA) program developed during the NEESWood program was used to optimize the 10 modeling parameters while minimizing the cumulative energy difference between the experimental and model behavior. Average modified Stewart modeling parameters for all SIP wall configurations are listed in Tables 11 to 13. In general, before failure, the modified Stewart model adequately followed the experimental data as observed in the difference between experimental and model cumulative hysteric energy. Appendix C contains tables and cyclic load-deformation curves for experimental and modified Stewart models for all tested walls.

## Walls Constructed without Openings

### Single SIPs with Various Aspect Ratios

Table 4 shows summary results for SIPs of various aspect ratios with hold-downs, and Table 5 shows results for the same type of SIPs without hold-downs. Stiffness of SIPs was taken as the slope of a line between the origin and the deformation at 40% of the maximum load. Unit stiffness is the stiffness value divided by the total length of the wall.

Figure 14 shows the unit stiffness and aspect ratio for single SIPs with and without hold-downs. For both the SIPs with and without hold-downs, the unit stiffness increased with increasing wall length or lower aspect ratios. Except for the 4:1 aspect ratio, the unit stiffness appeared to vary linearly with wall length. Unit stiffness decreased by 81% and 84% for SIPs with and without hold-downs between the 1:1 and



**Table 8—Equivalent energy elastic–plastic parameters for single-panel SIP walls**

Aspect ratio	Positive response						Negative response					
	$P_{yield}$ (kN)	$P_{peak}$ (kN)	$\Delta_{0.4Peak}$ (mm)	$\Delta_{yield}$ (mm)	$\Delta_{peak}$ (mm)	$\Delta_u$ (mm)	$P_{yield}$ (kN)	$P_{peak}$ (kN)	$\Delta_{0.4Peak}$ (mm)	$\Delta_{yield}$ (mm)	$\Delta_{peak}$ (mm)	$\Delta_u$ (mm)
With hold-downs												
1:1	42.67	47.40	8.2	18.6	55.2	79.7	-42.30	-46.16	-7.1	-16.4	-49.7	-66.1
2:1	18.27	20.12	11.8	26.9	76.3	121.2	-19.87	-21.70	-12.96	-29.7	-61.2	-113.5
3:1	11.79	13.58	20.8	45.3	123.0	135.8	-11.49	-12.79	-25.9	-58.4	-110.4	-152.1
4:1	8.88	9.88	30.8	69.4	144.8	179.5	-8.32	-9.71	-25.5	-54.5	-155.4	-160.1
Without hold-downs												
1:1	13.50	14.90	2.2	4.9	38.6	49.5	-13.55	-14.96	-2.0	-4.4	-17.1	-34.6
2:1	5.27	5.88	4.7	10.8	48.0	72.4	-5.26	-5.85	-4.6	-10.3	-46.6	-81.0
3:1	3.21	3.50	8.5	19.7	63.6	119.5	-3.03	-3.34	-9.3	-21.2	-66.4	-104.4
4:1	2.12	2.36	5.7	12.8	62.1	117.1	-1.89	-2.81	-11.4	-24.5	-74.4	-111.1

**Table 9—Equivalent energy elastic–plastic parameters for multiple-panel SIP walls without openings**

Configuration	Positive response						Negative response					
	$P_{yield}$ (kN)	$P_{peak}$ (kN)	$\Delta_{0.4Peak}$ (mm)	$\Delta_{yield}$ (mm)	$\Delta_{peak}$ (mm)	$\Delta_u$ (mm)	$P_{yield}$ (kN)	$P_{peak}$ (kN)	$\Delta_{0.4Peak}$ (mm)	$\Delta_{yield}$ (mm)	$\Delta_{peak}$ (mm)	$\Delta_u$ (mm)
Two panels	35.39	40.03	5.9	13.1	44.1	61.5	-37.44	-41.16	-6.7	-15.2	-44.4	-59.1
Three panels	48.64	54.94	3.15	7.03	35.64	52.88	-52.26	-59.56	-3.21	-7.04	-42.9	-59.9
Five panels	80.75	89.38	4.2	9.5	54.5	69.0	-79.77	-90.26	-8.6	-19.2	-57.1	-74.9

**Table 10—Equivalent energy elastic–plastic parameters for multiple-panel SIP walls with openings**

Configuration	Positive response						Negative response					
	$P_{yield}$ (kN)	$P_{peak}$ (kN)	$\Delta_{0.4Peak}$ (mm)	$\Delta_{yield}$ (mm)	$\Delta_{peak}$ (mm)	$\Delta_u$ (mm)	$P_{yield}$ (kN)	$P_{peak}$ (kN)	$\Delta_{0.4Peak}$ (mm)	$\Delta_{yield}$ (mm)	$\Delta_{peak}$ (mm)	$\Delta_u$ (mm)
201	30.57	34.21	5.4	12.0	48.2	80.4	-32.94	-36.47	-5.5	-12.4	-42.2	-61.9
202	41.04	45.51	6.9	15.5	56.3	87.9	-38.54	-46.08	-7.3	-15.3	-42.1	-49.2
203	56.61	64.33	5.2	11.4	40.1	61.4	-61.83	-68.53	-5.2	-11.8	-37.6	-63.7
204	39.67	43.48	5.3	12.1	38.5	69.1	-40.93	-46.03	-6.7	-14.9	-33.5	-45.1
205	43.77	48.49	5.0	11.2	38.3	60.5	-45.77	-51.19	-5.3	-11.8	-32.7	-54.2
206	56.24	63.20	4.0	8.9	33.3	59.6	-60.36	-67.68	-6.1	-13.5	-41.1	-63.2
207	28.45	32.07	6.4	14.1	39.0	70.9	-31.23	-34.42	-7.0	-15.8	-35.8	-43.9

4:1 aspect ratio panels. Interestingly, for all the aspect ratios, the unit stiffness of walls with hold-downs was only slightly greater than that for walls without hold-downs, indicating that the effect of hold-downs at the service level for SIP walls was minimal for unit stiffness.

The big difference for SIP walls constructed with and without hold-downs can be seen in Figure 15 for unit shear, which is the peak lateral shear load divided by the associated wall length. SIPs with hold-downs were at least three times stronger than SIPs without hold-downs. In both cases, unit shear strength improved with increasing wall length. Strength increased 33% for panels without

hold-downs and 19% for panels with hold-downs between the 1:1 and 4:1 aspect ratio SIPs. As with unit stiffness, the unit shear was approximately linear for SIP walls with and without hold-downs.

### Multiple SIPs

An investigation of unit stiffness and shear similar to single-panel SIPs was undertaken for multiple-panel SIP walls without openings (Table 6). All multiple-panel SIP walls were constructed with a block spline detail. Figure 16 shows the unit stiffness for a single 2:1 aspect ratio SIP wall and all the multiple SIP wall configurations with no openings. First, unit stiffness of a two-panel SIP wall with a block

**Table 11—Modified Stewart parameters for single-panel SIP walls with and without hold-downs**

Aspect ratio	$K_o$ (kN/mm)	$r_1$	$r_2$	$r_3$	$r_4$	$F_o$ (kN)	$F_i$ (kN)	$\Delta$ (mm)	$\alpha$	$\beta$
With hold-downs										
1:1	4.141	0.043	-0.163	1.610	0.014	38.82	3.194	47.78	0.69	1.09
2:1	0.966	0.079	-0.126	1.094	0.027	17.95	2.082	62.73	0.65	1.07
3:1	0.399	0.205	-0.195	1.162	0.034	5.29	0.652	92.49	0.25	1.05
4:1	0.199	0.041	-0.371	1.390	0.032	9.00	0.857	143.70	0.50	1.07
Without hold-downs										
1:1	5.650	0.052	-0.031	1.010	0.007	10.13	1.733	17.59	1.00	1.21
2:1	0.636	0.074	-0.074	1.010	0.030	4.29	1.244	49.26	1.00	1.07
3:1	0.224	0.014	-0.093	2.312	0.016	3.16	0.319	66.03	0.84	1.05
4:1	0.240	0.067	-0.036	1.584	0.007	1.54	0.225	41.53	0.91	1.06

**Table 12—Modified Stewart parameters for multiple-panel SIP walls without openings**

Configuration	$K_o$ (kN/mm)	$r_1$	$r_2$	$r_3$	$r_4$	$F_o$ (kN)	$F_i$ (kN)	$\Delta$ (mm)	$\alpha$	$\beta$
Two panels	3.502	0.046	-0.149	1.897	0.016	34.72	3.250	42.91	0.66	1.08
Three panels	10.825	0.056	-0.096	2.252	0.007	37.16	7.006	35.70	0.791	1.151
Five panels	7.330	0.061	-0.274	1.009	0.014	72.56	7.015	53.01	0.70	1.08

**Table 13—Modified Stewart parameters for multiple-panel SIP walls with openings**

Configuration	$K_o$ (kN/mm)	$r_1$	$r_2$	$r_3$	$r_4$	$F_o$ (kN)	$F_i$ (kN)	$\Delta$ (mm)	$\alpha$	$\beta$
201	3.878	0.083	-0.104	1.010	0.012	23.35	2.341	40.66	0.65	1.07
202	3.478	0.033	-0.124	1.037	0.022	39.14	3.061	52.45	0.56	1.08
203	7.407	0.114	-0.131	2.007	0.011	41.09	4.843	35.20	0.48	1.05
204	3.938	0.037	-0.083	1.010	0.034	42.49	3.290	32.86	0.70	1.12
205	5.195	0.044	-0.096	1.047	0.009	43.61	3.585	31.60	0.78	1.13
206	6.975	0.095	-0.082	1.010	0.013	45.47	4.764	31.64	0.59	1.09
207	2.662	0.016	-0.111	1.056	0.013	35.28	2.690	28.70	0.81	1.07

spline was not quite double that of a single 2:1 aspect ratio SIP, but as the number of panels increased, unit stiffness was steady or decreased slightly. Also shown in Figure 16 is the unit stiffness for the 1:1 aspect ratio SIP wall. This 1:1 panel had a unit stiffness 12% greater than the two-panel SIP wall with a block spline. Comparing the two- to five-panel configurations, the unit stiffness for the longer wall was 87% of the shorter wall value. For unit shear, the single 2:1 SIP wall had the highest value, and with each additional panel added to the wall, the unit shear decreased as shown in Figure 17. This decrease appeared to be linear with the ratio between the two-panel and single SIP at 0.97, whereas the same ratios for the three- and five-panel SIPs were 0.91 and 0.85, respectively. Also shown in Figure 17 is the unit shear for the 1:1 SIP to show that the increase in unit shear was not as significant as the change in unit stiffness. Kochkin

and others (2015) noted a 25% decrease in the unit shear between a two-panel (one spline joint) and five-panel (four spline joints) wall configuration with a block spline joint. The tests in this study, however, demonstrated only a 12% decrease with a lighter nailing schedule for the two- and five-panel configuration tests in the phase.

### Seismic Equivalency Parameters

Because there are similarities between the responses of light-frame wood and SIP walls, which have been noted, a more detailed comparison is warranted. Based on the cyclic test results obtained from this study, a detailed analysis in accordance with ICC-ES AC04 was conducted. AC04 appendix A was created to provide a methodology for benchmarking SIP cyclic test data to light-frame walls sheathed with wood structural panels and was subsequently

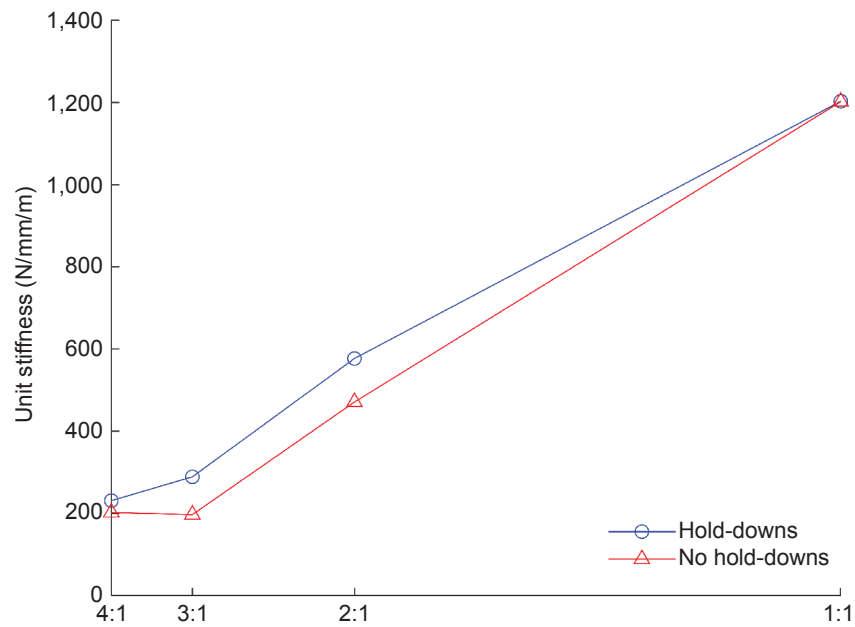

Figure 14. Unit stiffness for single-panel SIP tests with different aspect ratios.

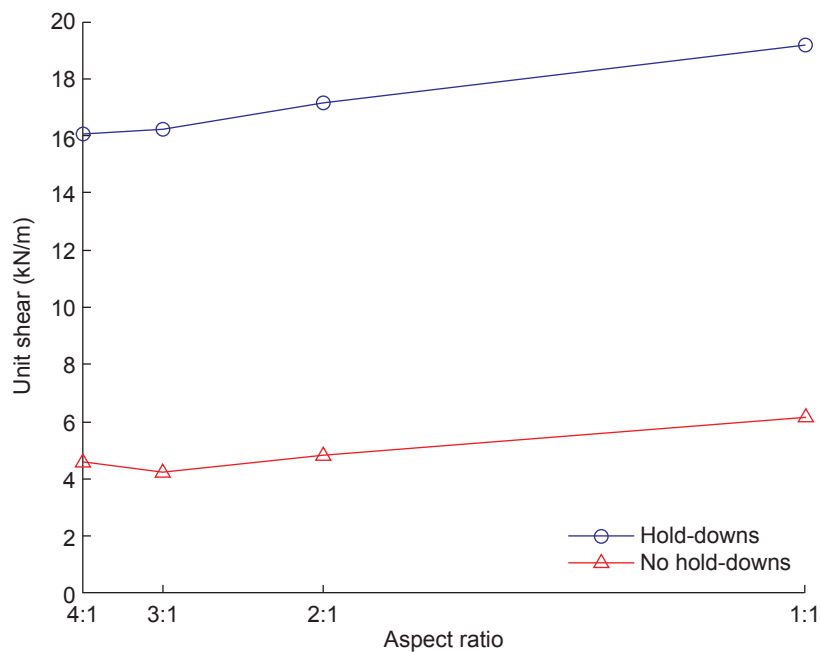

Figure 15. Unit strength for single-panel SIP tests with different aspect ratios.

adopted in ASTM D7989 (ASTM 2019b). The criteria are intended to confirm compatibility with a code-defined seismic-force resisting system for light-frame walls sheathed with wood structural panels (i.e., System A-13) in accordance with table 12-2.1 of American Society of Civil Engineers (ASCE) 7-10 (ASCE 2010). The walls summarized herein are considered “Assembly C” in accordance with AC04.

The first criterion is intended to provide similar ductility capacity as light-frame walls sheathed with wood structural panels, which is determined by dividing the ultimate deflection by the deflection at the allowable stress design (ASD) value. The ductility capacity is expected to be equal to or greater than 11. The second criterion is intended to show that the ultimate failure deflection of the walls (drift capacity) is similar to that of light-frame walls sheathed with wood structural panels. The drift capacity is expected to be equal to or greater than  $0.028H$ , where  $H$  is the height



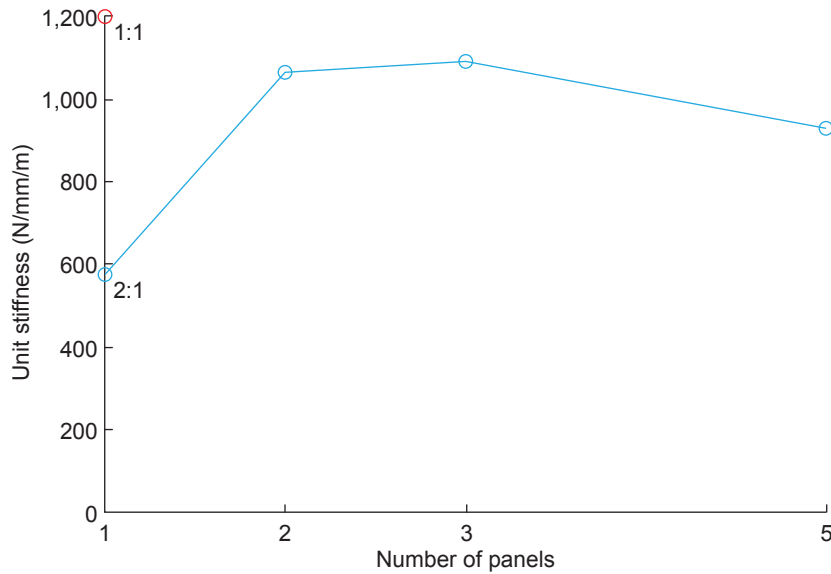

Figure 16. Unit stiffness for multiple-panel SIP tests without openings.

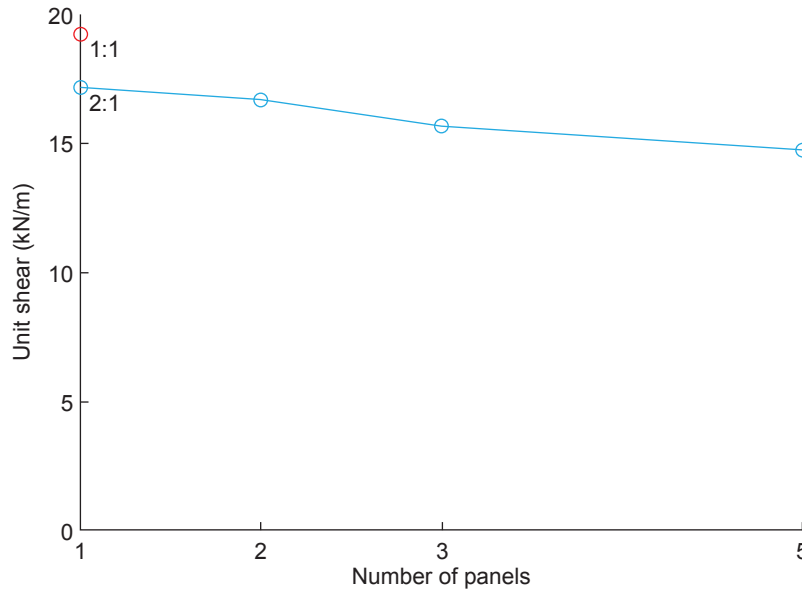

Figure 17. Unit strength for multiple-panel SIP tests without openings.

of the wall. The final criterion is intended to provide load factors (overstrength capacity) that are similar to light-frame walls sheathed with wood structural panels by dividing the peak strength by the design value yet limits the overstrength capacity of the panels. The overstrength capacity is expected to be between 2.5 and 5.0.

One of the underlying assumptions of the ICC-ES AC04 analysis is the determination of the ASD value. The assumed ASD values for these walls are based on the ICC-ES evaluation report ESR-1539 (ICC-ES 2016). Because the SIP facers were nominal 11-mm (7/16-in.) rated sheathing, the seismic design values published in table 8 of ESR-1539

were used. The single-sided wall design values, when nailed to the Douglas Fir–Larch framing, were 2.7 kN/m (185 lb/ft) for the 2.87-mm- (0.113-in.-) diameter nails spaced at 152 mm (6 in.) on center. The design values were further decreased for nailing into spruce–pine–fir framing. Because the SIP walls were nailed on both sides, the ESR-1539 table 8 ASD value was doubled and resulted in a design value of 4.97 kN/m (340 lb/ft) for 152-mm (6-in.) on-center nail spacing.

Based on the information presented in Table 14, single-panel SIP walls with 1:1 and 2:1 aspect ratios in this study met the AC04 cyclic performance criteria. For the full

**Table 14—Mean cyclic performance parameters from walls tested and analyzed in accordance with ICC-ES AC04**

Wall detail	$P_{ASD}$ (kN/m)	$\Delta_{ASD}$ (mm)	$\bar{P}_{peak}/L_{wall}$ (kN/m)	$\bar{\Delta}_u$ (mm)	$\frac{\bar{\Delta}_u}{\Delta_{ASD}}$ <sup>a</sup>	Drift capacity <sup>b</sup>	$\frac{\bar{P}_{peak}}{P_{ASD}}$ <sup>c</sup>
Single-panel SIP with hold-downs							
Aspect ratio:							
1:1	4.97	4.71	19.18	73	15.5	0.030H	3.86
2:1	4.97	8.39	17.15	117	14.0	0.048H	3.45
3:1	4.97	17.10	16.22	144	8.4	0.059H	3.26
4:1	4.97	20.46	16.07	170	8.3	0.070H	3.23
Multiple-panel SIPs without openings							
Configuration:							
2	4.97	4.08	16.6	60	14.8	0.025H	3.35
3	4.97	4.00	15.7	56	14.1	0.023H	3.15
5	4.97	5.04	14.7	72	14.3	0.030H	2.96

<sup>a</sup>Ultimate deflection divided by deflection at design value (ductility capacity). ICC-ES AC04 appendix A requires this property to be equal to or greater than 11.  
<sup>b</sup>Minimum post-peak displacement (drift capacity). AC04 appendix A requires this property to be equal to or greater than 0.028H, where H is the height of the wall, based on tests following the CUREE loading protocol.  
<sup>c</sup>Peak strength divided by design value (over strength capacity). AC04 appendix A requires this property to be between 2.5 and 5.0.

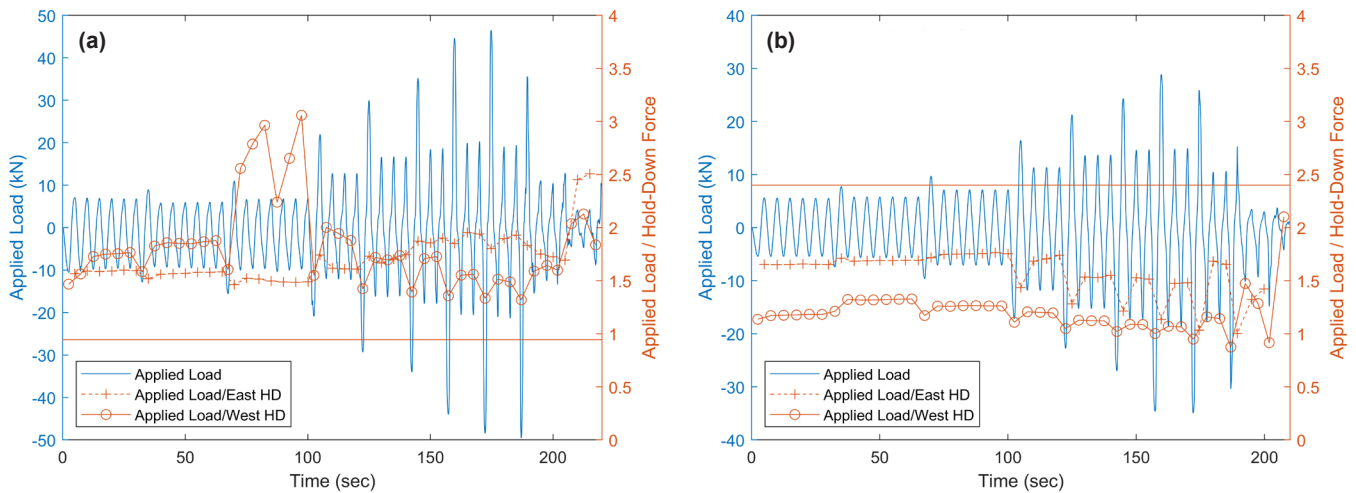

**Figure 18. Ratio of applied load to hold-down force for (a) a representative 2.4- by 2.4-m panel and (b) configuration 207 of the multiple-panel wall with openings.**

ASD load, the 3:1 and 4:1 aspect ratios did not meet the AC04 cyclic performance criteria. SDPWS-2015, Section 4.3.4.2, contains provisions to adjust the wood structural panel design load for aspect ratios greater than 2:1; applying this provision decreases the ASD load and deformation for the 3:1 ratio to 4.35 kN/m (298 lb/ft) and 12.9 mm (0.5 in.), respectively, and for the 4:1 ratio to 3.72 kN/m (254.9 lb/ft) and 15.8 mm (0.6 in.), respectively. As a result, the overstrength capacity increased for both aspect ratio increases and was still within the limits. Similarly, the ductility capacity increased for both aspect ratios, but although the 3:1 panel passed the criteria, the 4:1 panel was slightly below the criteria value. Although the two- and three-panel SIP walls were below the 0.028H required drift

capacity, they met the ductility and overstrength capacity. Only the five-panel multiple SIP wall configuration met all the performance criteria for light-frame wall equivalency. It was observed that as the number of panels increased, the ductility capacity increased and the overstrength capacity decreased. Because it was not appropriate to apply the seismic equivalency test to multiple-panel SIP walls with openings, these configurations were compared with the PSW design methodology.

**Performance of Hold-Downs**

As part of this study, hold-down forces were measured during the entire cyclic loading to evaluate their effectiveness in carrying the overturning forces. For each cycle, the ratio of both the minimum and maximum applied

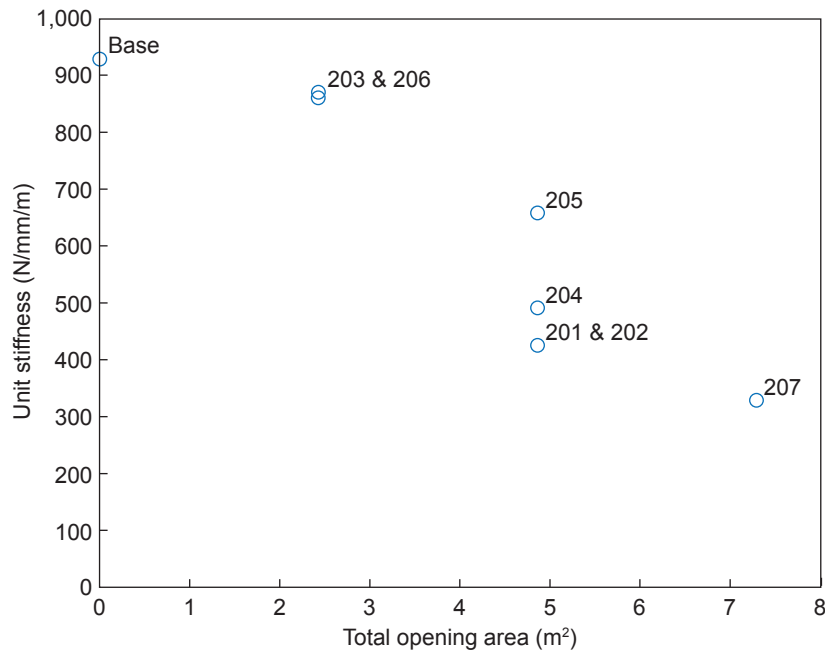

Figure 19. Unit shear wall stiffness for multiple-panel SIP tests with openings.

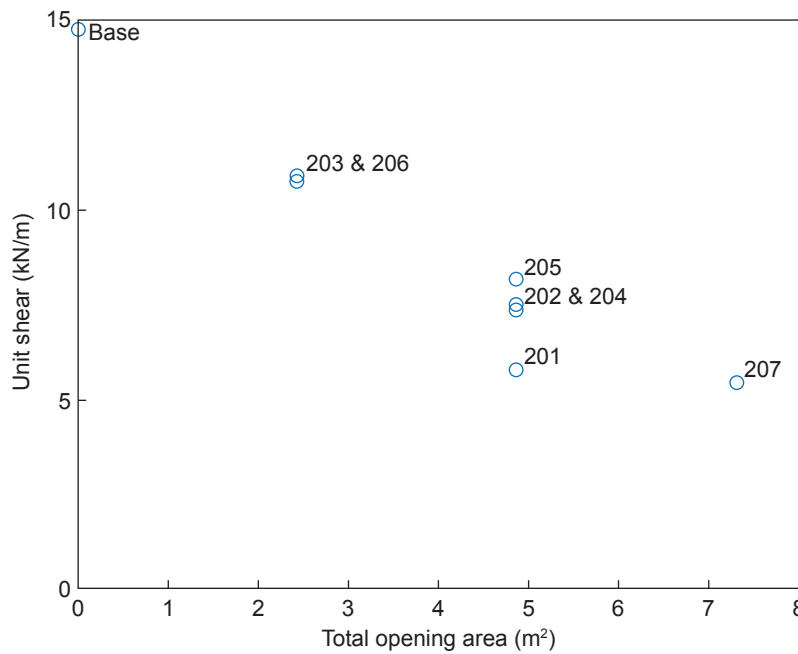
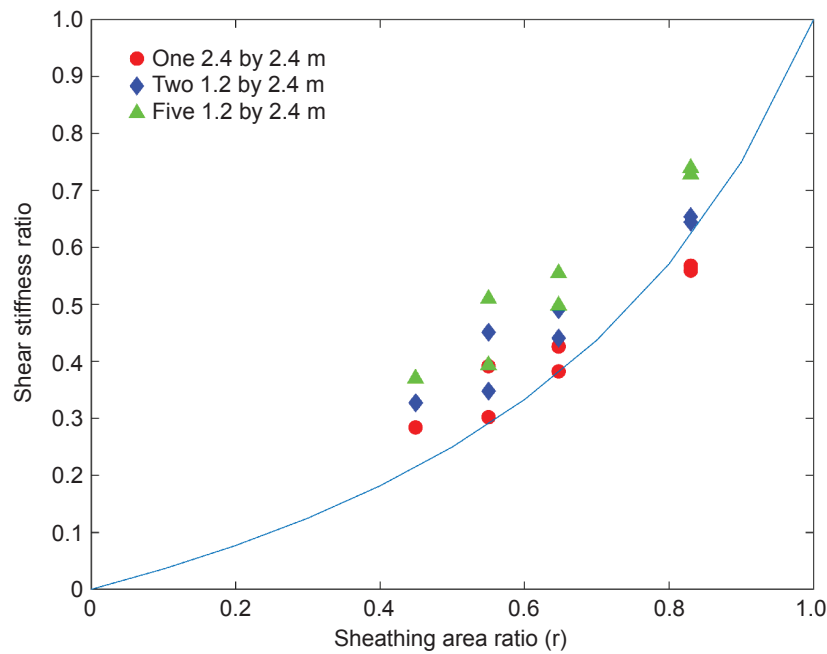

Figure 20. Unit shear wall strength for multiple-panel SIP tests with openings.

load to the hold-down force was calculated. Figure 18 illustrates hold-down forces with respect to applied loading for a 1:1 aspect ratio single-panel wall and a Configuration 207 multiple-panel wall with openings (Table 7). For the single-panel wall, calculated ratios were above the theoretical condition (constant line), which assumes that only the hold-downs resisted the overturning forces. Values above the constant line indicate that other structural components, e.g., anchor bolts, are providing

load paths to resist the applied overturning forces. In the case of multiple-panel wall configurations with openings, Configuration 207 represents the assembly with the largest opening area. For this configuration, the hold-down ratios were below the theoretical ratio (Fig. 18b), which indicates that the maximum resisting moment was not being achieved to resist the applied force.





**Figure 21. Perforated shear stiffness ratio using three baseline configurations for shear strength ratio determination.**

Appendix D contains similar figures for all the tested configurations with hold-downs. These figures show that all the single- and multiple-panel walls without openings had ratios above the idealized model. For all the remaining configurations of walls with openings, ratios varied between the single-panel and Configuration 207 walls. This variation is strongly related to the total opening area. As the total opening area increased, the calculated ratios changed from values above the idealized ratio, i.e., constant line, to values below that line.

### **Perforated Shear Wall Design Equations**

Table 7 summarizes results for SIP walls with openings, and Figures 19 and 20 show the unit stiffness and unit shear change with the total opening area. As the total opening area increased, unit stiffness and shear decreased, but for Configurations 201, 202, 204, and 205, the total opening area parameter was not sufficient. All these configurations had the same total opening area, but the location, size, or number of individual openings varied. As a result, stiffness and strength varied significantly for these four configurations. Apparently, the location of openings, the use of lower aspect ratio panels, and the presence of one or more panels in a row had an effect. Currently, the PSW method is used for walls that have openings and hold-downs only at either end of the wall line and is used to evaluate peak load and stiffness at 0.4 peak load. The PSW methodology is used to adjust a baseline lateral strength for a fully anchored SIP wall by accounting for the total opening area. Because unit shear and unit stiffness for fully anchored SIP walls depend on the wall length, the PSW method will be evaluated with a single 1.2- by 2.4-m (4- by 8-ft) panel, two 1.2- by 2.4-m (4- by 8-ft) panels with the block spline

connection, and five 1.2- by 2.4-m (4- by 8-ft) panels with block spline connection as baselines for comparison purposes.

Figures 21 and 22 graphically plot the sheathing ratio versus the shear stiffness ratio or shear strength ratio. The stiffness or strength ratio is the experimental unit stiffness or strength divided by the baseline unit stiffness or strength. According to SDPSW-2015, if the panel aspect ratio is greater than 3.5:1, it shall not be considered in the sum of the shear wall segments. This provision was applied to the strength (stiffness) ratio calculations for Configurations 201 and 202. The PSW relationship between sheathing ratio and unit stiffness or shear is shown as the solid line. Values above the line are considered conservative. Figure 21 shows that the PSW method closely predicts the shear stiffness ratio of the wall with openings. Using the 2.4- by 2.4-m (8- by 8-ft) panel as a baseline, only two configurations, 203 and 206, fell below the relationship. All the remaining configurations, regardless of baseline, were above the strength (stiffness) ratio relationship. Although the PSW method gives conservative results for stiffness, the most conservative results were for configurations with a smaller sheathing area ratio.

Figure 22 shows that for any choice of baseline, the PSW method gave conservative results for all shear strength ratio predictions. All data points were above the curve and generally followed the shape of the relationship with the sheathing ratio. The most conservative results came from using the five 1.2- by 2.4-m (4- by 8-ft) panel configuration as the baseline. Based on these configurations, it appeared to be justified to apply the PSW approach to SIP wall configurations with openings. Furthermore, using a 2.4- by

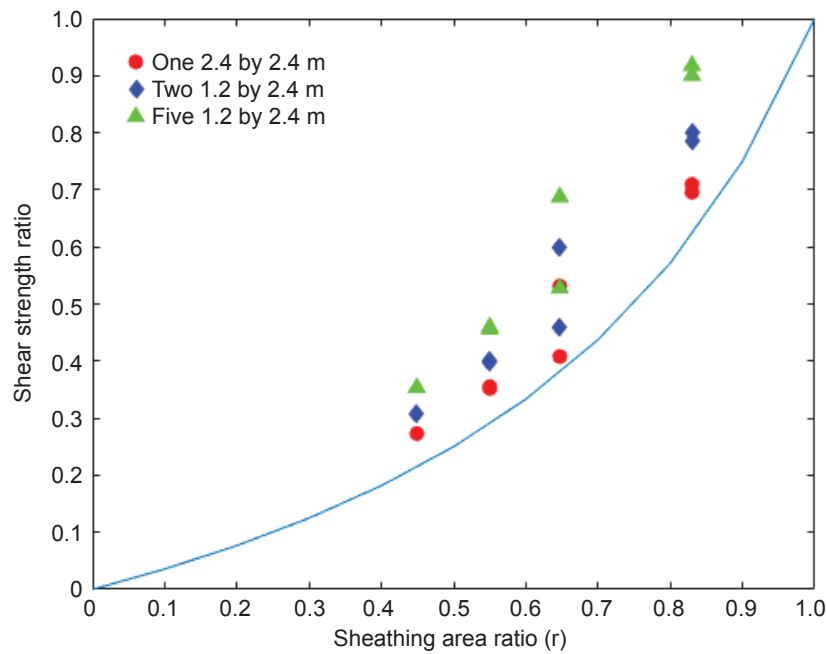

**Figure 22. Perforated shear strength ratio using three baseline configurations for shear strength ratio determination.**

2.4-m (8- by 8-ft) configuration as the baseline gave the best predictions of both the strength and stiffness ratios as a function of sheathing area ratio.

## Conclusions

The results of this testing program provided information on the cyclic performance of SIP shear walls with various aspect ratios tested as single-panel wall segments, as multiple-panel walls without openings, or as multiple-panel walls with openings. Single- and multiple-panel SIP walls were evaluated for seismic equivalency to traditional light-frame wall construction. Finally, for multiple-panel SIP walls with openings, the applicability of the PSW method was also explored.

Specific observations based on the test results include the following:

1. The measured unit shear capacity for fully anchored SIP shear wall segments ranged from 16.13 kN/m (1,105.3 lb/ft) to more than 19.18 kN/m (1,314.3 lb/ft) depending on the aspect ratio of the segment.
2. The measured unit stiffness was similar for single-panel SIP walls with and without hold-downs.
3. The measured unit stiffness for single-panel SIP walls with and without hold-downs varied by a factor of five between a 1:1 and 4:1 aspect ratio.
4. Fully anchored single-panel SIP walls (with hold-downs) had unit shear capacities at least three times that of single-panel SIP walls without hold-downs.
5. The unit shear wall capacity and stiffness of SIP shear wall segments decreased with increasing number of panels jointed with nailed block spline connections. A 12% decrease in unit shear was observed for a 6.1-m (20-ft) wall with four spline joints compared with a 2.4-m (8-ft) wall with one spline joint.
6. The unit shear wall capacity of SIP shear wall segments decreased with increasing aspect ratio with a 17% decrease for a 0.6-m (2-ft) segment compared with a 2.4-m (8-ft) segment.
7. The unit stiffness of SIP shear wall segments decreased with increasing aspect ratio with a maximum 81% decrease for a 0.6-m (2-ft) segment compared with a 2.4-m (8-ft) segment.
8. Lateral load resistance of single-panel SIP walls with aspect ratios of 1:1, 2:1, and 3:1 and five-panel SIP walls without openings satisfied the cyclic performance parameters of overstrength, drift, and ductility capacities, as defined in ICC-ES acceptance criteria AC04 and ASTM D7989, which is equivalent to light-frame walls.
9. For any choice of SIP baseline wall configuration, the PSW method gave conservative results for all strength ratio predictions.
10. Based on these configurations, it seemed justified to apply the PSW approach to SIP wall configurations with openings for both stiffness and strength adjustments.

## Literature Cited

- APA. 2010. Racking test of structural insulated panels (SIPs) with various bearing conditions. APA Report T2010P-17. Tacoma, WA: APA — The Engineered Wood Association.
- APA. 2018. ANSI/APA PRS 610.1 Standard for performance-rated structural insulated panels in walls applications. Tacoma, WA: APA — The Engineered Wood Association. 18 p.
- ASCE. 2010. ASCE 7-10 Minimum design loads for buildings and other structures, Third Printing. Reston, VA: American Society of Civil Engineers.
- ASTM. 2014a. E564-06. Standard practice for static load test for shear resistance of framed walls for buildings. West Conshohocken, PA: American Society for Testing and Materials International.
- ASTM. 2014b. E2126-11. Standard test methods for cyclic (reversed) load test for shear resistance of vertical elements of the lateral force resisting systems for buildings. West Conshohocken, PA: American Society for Testing and Materials International. 15 p.
- ASTM. 2019a. A307-14. Standard specification for carbon steel bolts, studs, and threaded rod. West Conshohocken, PA: American Society for Testing and Materials International.
- ASTM. 2019b. D7989. Standard practice for demonstrating equivalent in-plane lateral seismic performance to wood-frame shear walls sheathed with wood structural panels. West Conshohocken, PA: American Society for Testing and Materials International.
- AWC. 2015. ANSI/AWC SDPWS-2015. Special design provisions for wind & seismic with commentary. Leesburg, VA: American Wood Council.
- Donovan, L.T.; Memari, A.M. 2015. Feasibility study of determination of seismic performance factors for structural insulated panels. *Journal of Architectural Engineering*. 21(2): B4014007-1:13.
- FEMA. 2009. Quantification of building seismic performance factors. FEMA P695. Washington, DC: Federal Emergency Management Agency.
- ICC-ES. 2015. Acceptance criteria for sandwich panels — AC04. Brea, CA: International Code Council-Evaluation Service, LLC.
- ICC-ES. 2016. ESR-1539. Power-driven staples and nails. International Staple, Nail and Tool Association. Brea, CA: International Code Council-Evaluation Service, LLC.
- Jamison, J.B. 1997. Monotonic and cyclic performance of structurally insulated panel shear walls. Blacksburg, VA: Virginia Polytechnic Institute and State University. 97 p. M.S. thesis.
- Kermani, A.; Hairstans, R. 2006. Racking performance of structural insulated panels. *Journal of Structural Engineering*. 132 (11): 1806-1812.
- Kochkin, V.; Rammer, D.R.; Kauffman, K.; Williamson, T.; Ross, R.J. 2015. SIP shear walls: cyclic performance of high-aspect-ratio segments and perforated walls. Research Paper FPL-RP-682. Madison, WI: U.S. Department of Agriculture, Forest Service, Forest Products Laboratory. 19 p.
- Mosalam, K.M.; Günay, S. 2012. Seismic performance of energy efficient structural insulated panels. *Wood Design Focus*. 22(1): 12-18.
- Pang, W.C.; Rosowsky, D.V.; Pei, S.; van de Lindt, J.W. 2007. Evolutionary parameter hysteretic model for wood shear walls. *ASCE Journal of Structural Engineering*. 133(8): 1118-1129.
- Sugiyama, H.; Matsumoto, T. 1994. Empirical equations for the estimation of racking strength of a plywood sheathed shear wall with openings. *Summary of Technical Papers, Annual Meetings, Trans. of A.I.J. Japan*. pp. 89-90.
- Terentiuk, S.; Memari, A.M. 2012. In-plane monotonic and cyclic racking load testing of structural insulated panels. *Journal of Architectural Engineering*. 18(4): 261-275. 10.1061/(ASCE)AE.1943-5568.0000084.
- Yasumura, M.; Sugiyama, H. 1984. Shear properties of plywood sheathed wall panels with openings. *Transaction of the Architectural Institute of Japan*. No. 338. April. pp. 88-98.
- Yeh, B.; Skaggs, T.; Wang, X.; Williamson, T. 2018. Lateral load performance of SIP walls with full bearing. General Technical Report FPL-GTR-251. Madison, WI: U.S. Department of Agriculture, Forest Service, Forest Products Laboratory. 23 p.



## Appendix A—Observations and Failure Modes for Various Wall Configurations

**Table A1—Observations and failure modes for each test of single-panel walls with hold-downs**

Aspect ratio	Specimen number	Observations and failure
1:1	1	Failure between top let-in framing and SIP OSB sheathing caused by extreme nail deformation. Prior to failure, a significant opening was observed between bottom plate and SIP panel edge caused by the sliding and rocking motion.
	2	Failure between top let-in framing and SIP OSB sheathing caused by extreme nail deformation. Prior to failure, a significant opening was observed between bottom plate and SIP panel edge caused by the sliding and rocking motion.
	3	Failure between top let-in framing and SIP OSB sheathing caused by extreme nail deformation. Prior to failure, a significant opening was observed between bottom plate and SIP panel edge caused by the sliding and rocking motion.
2:1	1	Failure between top let-in framing and SIP OSB sheathing caused by extreme nail deformation. Prior to failure, a significant opening was observed between bottom plate and SIP panel edge caused by the sliding and rocking motion.
	2	Failure between top let-in framing and SIP OSB sheathing caused by extreme nail deformation. Prior to failure, a significant opening was observed between bottom plate and SIP panel edge caused by the sliding and rocking motion.
	3	Failure between top let-in framing and SIP OSB sheathing caused by extreme nail deformation. Prior to failure, a significant opening was observed between bottom plate and SIP panel edge caused by the sliding and rocking motion.
3:1	1	Failure between top let-in framing and the SIP OSB sheathing caused by extreme nail deformation.
	2	Failure between top let-in framing and the SIP OSB sheathing caused by extreme nail deformation.
	3	Failure between top let-in framing and the SIP OSB sheathing caused by extreme nail deformation.
4:1	1	Failure between top let-in framing and the SIP OSB sheathing caused by extreme nail deformation.
	2	Failure between top let-in framing and the SIP OSB sheathing caused by extreme nail deformation. Splitting of top let-in framing observed at exposed ends. Rolling shear failure of the sole plate at west end.
	3	Failure between top let-in framing and the SIP OSB sheathing caused by extreme nail deformation. Splitting of top let-in framing observed at exposed ends.

**Table A2—Observations and failure modes for each test of single-panel walls without hold-downs**

Aspect ratio	Specimen number	Observations and failure
1:1	1	Panel exhibited both sliding and rocking. Failure was observed first at the bottom let-in framing and the SIP OSB sheathing caused by extreme nail deformation. The let-in framing cross-grain bending failure was noted.
	2	Panel exhibited both sliding and rocking. Failure was observed first at the bottom let-in framing and the SIP OSB sheathing caused by extreme nail deformation.
	3	Panel exhibited both sliding and rocking. Failure was observed first at the bottom let-in framing and the SIP OSB sheathing caused by extreme nail deformation.
2:1	1	Panel exhibited both sliding and rocking. Initial failure was observed first at the bottom let-in framing and the SIP OSB sheathing caused by extreme nail deformation. Test was stopped when a similar failure was observed at the top of the SIP panel.
	2	Panel exhibited both sliding and rocking. Failure was observed first at the bottom let-in framing and the SIP OSB sheathing caused by extreme nail deformation.
	3	No video or notes.
3:1	1	Failure was observed between both the top and bottom let-in framing and the SIP OSB sheathing caused by extreme nail deformation in the same load cycle. The top plate split, and the nails withdrew from the top plate.
	2	Initial failure was caused by cross-grain bending of the bottom let-in framing after which the top let-in framing wood split near fasteners and the remaining nails withdrew.
	3	Failure was observed between both the top and bottom let-in framing and the SIP OSB sheathing caused by extreme nail deformation in the same load cycle.
4:1	1	Failure was observed between bottom let-in framing and the SIP OSB sheathing caused by extreme nail deformation. Upper roller support bore on top sill plate near the end of test.
	2	Initial failure was cross-grain bending of the let-in bottom plate. The ultimate failure occurred with the splitting of the top let-in plate and the excessive deformation of the fastener on the top and bottom side of the SIP panel.
	3	Failure was observed between both the top and bottom let-in framing and the SIP OSB sheathing caused by extreme nail deformation in the same load cycle. The bottom plate split, and the nails withdrew in the top plate.

**Table A3—Observations and failure modes for tests of multiple-panel walls without openings**

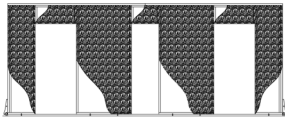
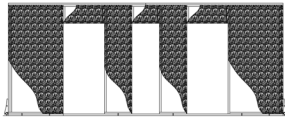
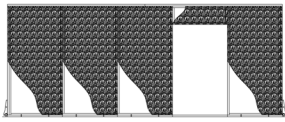
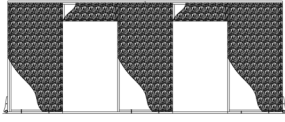

Configuration	Specimen number	Observations and failure
2	1	Failure between top let-in framing and the SIP OSB sheathing caused by extreme nail deformation. The east panel top fastener failed first in a push cycle, then the west panel top fasteners failed on the next pull loading. During the test, each panel rocked but the entire wall was also sliding.
	2	Failure between top let-in framing and the SIP OSB sheathing caused by extreme nail deformation. The east panel top fastener failed first in a push cycle, then the west panel top fasteners failed on the next pull loading. During the test, each panel rocked but the entire wall was also sliding and the SIP sheathing pushed the top plate so it looked like it was flexing along its length.
	3	Failure between top let-in framing and the SIP OSB sheathing caused by extreme nail deformation. The entire length of fasteners failed on the pulsing push cycle. During the test, each panel rocked but the entire wall was also sliding.
3	1	Steel base beam slipped near maximum loading condition. Failure between top let-in framing and the SIP OSB sheathing caused by extreme nail deformation.
	2	Failure between top let-in framing and the SIP OSB sheathing caused by extreme nail deformation. During the test, each panel rocked some but the entire wall appeared to slide more.
	3	Failure between top let-in framing and the SIP OSB sheathing caused by extreme nail deformation. During the test, each panel rocked some but the entire wall appeared to slide more.
5	1	Failure between top let-in framing and the SIP OSB sheathing caused by extreme nail deformation. During the test, each panel rocked some but the entire wall appeared to slide more. Some buckling of panels occurred in top corners caused by panels coming into contact.
	2	Failure between top let-in framing and the SIP OSB sheathing caused by extreme nail deformation. During the test, each panel rocked some but the entire wall appeared to slide more.
	3	Failure between top let-in framing and the SIP OSB sheathing caused by extreme nail deformation. During the test, each panel rocked some but the entire wall appeared to slide more.

**Table A4—Observations and failure modes for tests of multiple-panel walls with openings**

Configuration		Specimen number	Observations and failure
201	W  E	1 2 3	1 First west panel to header connection failed first and was the location of ultimate failure. The inner panel to head connection loosened next. 2 First east panel to header connection failed first and was the location of ultimate failure. Then the first east 2.4-m panel failed at the bottom plate. 3 Panel to header connections of the inner joints showed significant movement during the test. First west panel to header connection failed first and was the location of ultimate failure. The final failure was the first east panel to header connection.
202	W  E	1 2 3	1 First east panel to header connection failed first and was followed immediately by the first west panel to header connection. The test was concluded after this event. 2 First west panel lower east corner showed excessive uplift. Connections between the first west and first east panel and the associated header were the main degradation points. Test was concluded when top plate LVDT broke. 3 First east panel to header connection failed first and was followed immediately by the first west panel to header connection. The test was concluded after this event.
203	W  E	1 2 3	1 Door opening was located toward the west side of wall specimen (see Fig. B14). Slide of the wall section was observed. The west side panel to header connection failed but the loading was continued. The remaining three 1.02-m sections resisted the load in the push cycle but uplift of the west end increased significantly and the slip increased. On the pull cycle, the header compressed into the detached west 1.02-m panel. Testing concluded because of excessive deformation. 2 Door opening was located toward the east side of wall specimen (see Fig. B14). East panel to header connection, along with the let-in framing to panel fasteners failed first. After this happened, the east end of the three-panel set had significant uplift. 3 Door opening was located toward the east side of wall specimen (see Fig. B14). Prior to failure, the wall section was starting to slide and the east corner of the three-panel set was starting to uplift. East panel to header connection, along with the let-in framing to panel fasteners was the location of the significant failure. After this, the remaining section had significant sliding and uplift motion.
204	W  E	1 2 3	1 The middle panel and the inner corners of the outer panel fasteners that were connected to the bottom let-in framing loosened first, allowing the panel to uplift. Next, the west panel to header connection failed followed by the east panel to header connection. Finally, the inner panel to header connection failed. 2 The middle panel and the inner corners of the outer panel fasteners that were connected to the bottom let-in framing loosened first, allowing the panel to uplift. Next, the east panel to header connection failed, and finally, all the fasteners between the center panel and the let-in framing failed. 3 Slight uplift of the middle panel and inner corners of the outer panels was noted. The east panel to header connection failed, and immediately after, all the fasteners between the center panel and the lower let-in framing failed.

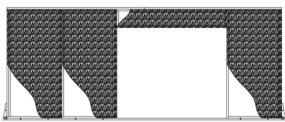
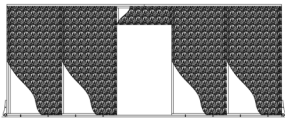

**Table A4—Observations and failure modes for tests of multiple-panel walls with openings—con.**

Configuration		Specimen number	Observations and failure
205	W  E	1	Large door opening was located toward the west side of wall specimen (see Fig. B16). Lower inner corners of the opening experienced uplift and cracking sounds prior to failure. Finally, west panel to header connection failed along with all the fasteners between the west end panel and the top let-in framing, resulting in failure of the wall system.
		2	Large door opening was located toward the west side of wall specimen (see Fig. B16). Lower inner corners of the opening experienced uplift and cracking sounds prior to failure. Finally, the west panel to header connection failed along with all the fasteners between the west end panel and the top let-in framing, resulting in failure of the wall system.
		3	Large door opening was located toward the east side of wall specimen (see Fig. B16). Lower inner corners of the opening experienced uplift and cracking sounds prior to failure. The east panel to header connection failed but the panel to let-in framing fasteners did not fail. With continued loading, the west side fasteners between panels and lower let-in framing, along with the fasteners at the bottom of the west end post failed at the end of the test.
206	W  E	1	Lower inner corners of the opening experienced a slight sliding and uplift. The west side of the opening panel to header connection failed first. With continued loading, the west panel and top let-in framing nails failed. Test was concluded when both the top and bottom let-in framing to panel fasteners on the eastside of the opening failed.
		2	Wall system was dominated by sliding. Failure occurred at all the fasteners between bottom let-in framing and four SIP panels. Sliding failure.
		3	Wall system had significant sliding. Prior to the failure between the west panel and header connection, most of the fasteners between the east panels and bottom let-in framing were broken. Test concluded when all fasteners at the bottom of the east panels failed.
207	W  E	1	Each end panel showed rocking behavior prior to wall failure. East header to panel connection failed first, followed by the west connection. With continued loading, all the fasteners between the panel and top let-in framing failed.
		2	Each end panel showed rocking behavior prior to wall failure. Both the west header to panel connection and the panel to let-in framing failed first. The west panel to header connection failure stopped the loading.
		3	Each end panel showed rocking behavior prior to wall failure. Both the east header to panel connection and the panel to let-in framing failed. The east end panel rotated up during the failure, and this terminated the wall loading.

# Appendix B—Equivalent Energy Elastic–Plastic Parameters and Curves for All SIP Configurations

## Tests for Single-Panel SIPs with Hold-Downs

**Table B1—EEEP parameters for single-panel SIPs with hold-downs**

Aspect ratio	Specimen number	Positive response						Negative response					
		$P_{yield}$ (kN)	$P_{peak}$ (kN)	$\Delta_{0.4Peak}$ (mm)	$\Delta_{yield}$ (mm)	$\Delta_{peak}$ (mm)	$\Delta_u$ (mm)	$P_{yield}$ (kN)	$P_{peak}$ (kN)	$\Delta_{0.4Peak}$ (mm)	$\Delta_{yield}$ (mm)	$\Delta_{peak}$ (mm)	$\Delta_u$ (mm)
1:1	1	38.40	44.39	6.7	14.6	52.7	83.0	-38.58	-42.73	-3.6	-8.1	-30.2	-59.1
	2	46.51	49.59	13.1	30.8	73.5	103.9	-44.90	-47.88	-12.5	-29.2	-65.8	-76.1
	3	43.11	48.23	4.7	10.4	39.4	52.3	-43.41	-47.86	-5.2	-11.8	-53.0	-63.1
	Average	42.67	47.40	8.2	18.6	55.2	79.7	-42.30	-46.16	-7.1	-16.4	-49.7	-66.1
2:1	1	17.60	19.28	13.6	31.1	64.5	117.9	-19.60	-21.18	-15.7	-36.2	-63.5	-121.8
	2	18.94	20.97	10.1	22.7	88.1	124.6	-20.13	-22.22	-10.2	-23.2	-58.8	-105.2
	3	17.89	20.03	9.5	21.1	65.1	117.2	-20.53	-22.58	-14.7	-33.3	-89.1	-119.7
	Average	18.27	20.12	11.8	26.9	76.3	121.2	-19.87	-21.70	-12.96	-29.7	-61.2	-113.5
3:1	1	11.92	13.60	18.6	40.7	87.7	108.5	-10.59	-12.47	-27.0	-57.4	-105.2	-114.2
	2	12.01	14.24	19.0	40.1	141.4	145.3	-12.11	-13.51	-18.2	-40.8	-114.5	-167.5
	3	11.44	12.89	24.8	55.1	139.9	153.5	-11.77	-12.39	-32.4	-77.0	-111.5	-174.5
	Average	11.79	13.58	20.8	45.3	123.0	135.8	-11.49	-12.79	-25.9	-58.4	-110.4	-152.1
4:1	1	9.04	10.01	37.8	85.4	139.9	164.0	-8.31	-9.40	-24.7	-54.7	-162.2	-168.6
	2 <sup>a</sup>												
	3	8.72	9.75	23.9	53.3	149.6	195.0	-8.32	-10.01	-26.2	-54.4	-148.5	-151.5
	Average	8.88	9.88	30.8	69.4	144.8	179.5	-8.32	-9.71	-25.5	-54.5	-155.4	-160.1

<sup>a</sup>Initial misalignment caused pulse displacement in first cycle, which led to unbalanced cyclic loading. Data not included in tables.

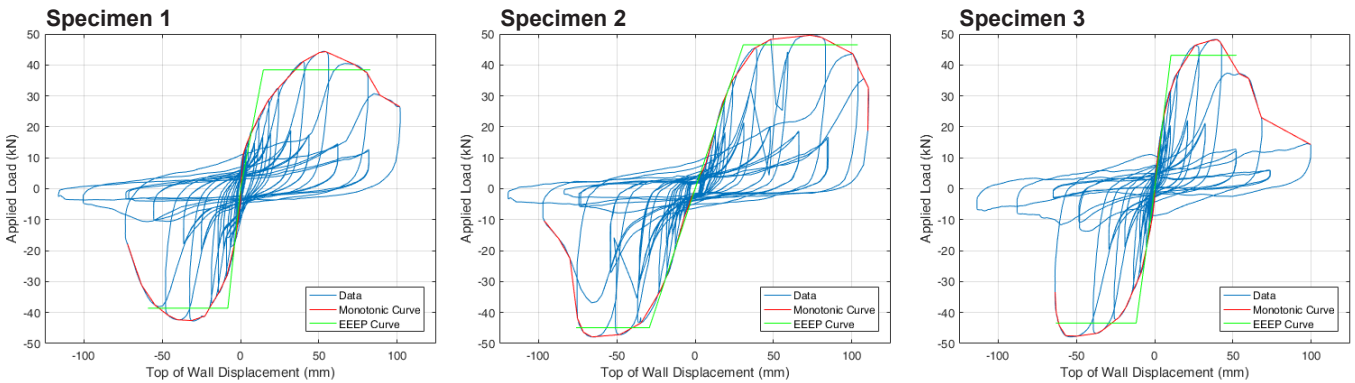

**Figure B1. EEEP curves for SIPs with a 1:1 aspect ratio (2.4 by 2.4 m).**

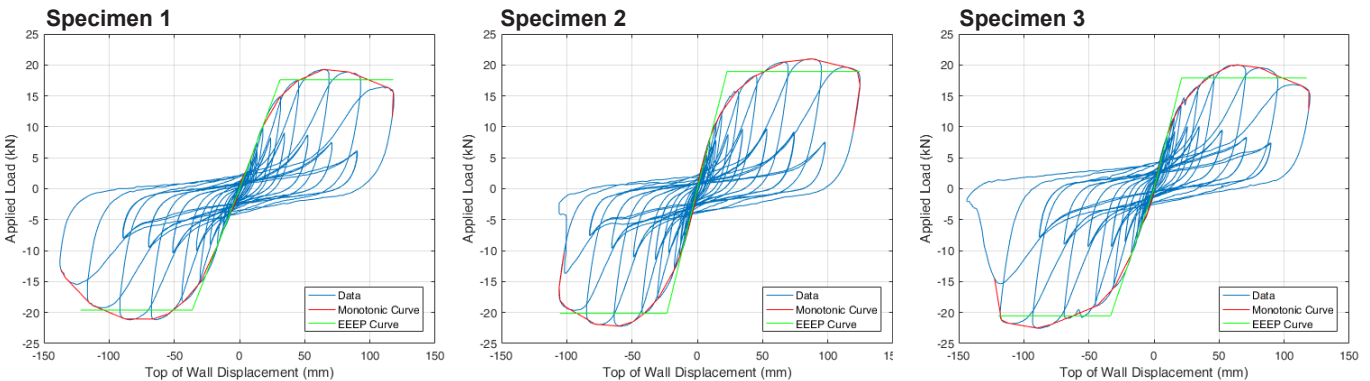

**Figure B2. EEEP curves for SIPs with a 2:1 aspect ratio (1.2 by 2.4 m).**

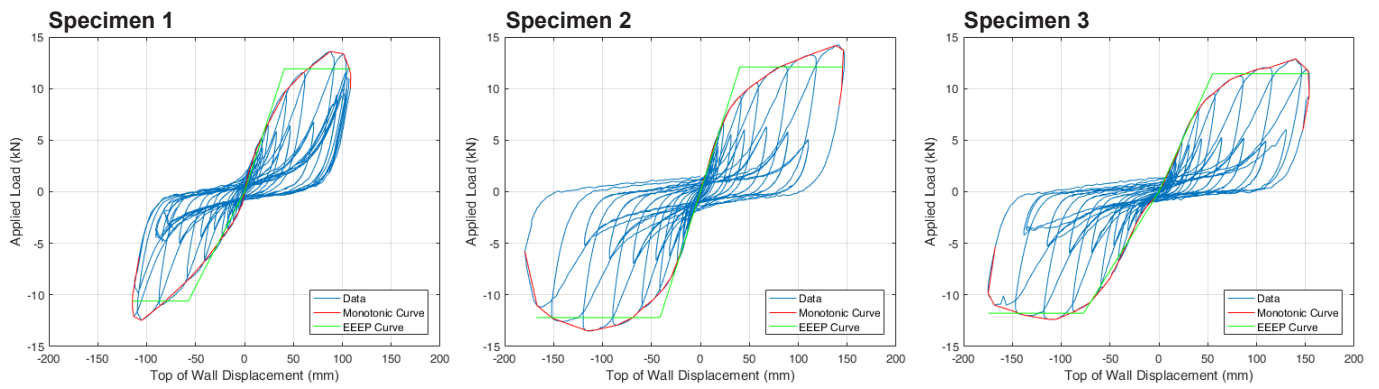

Figure B3. EEEP curves for SIPs with a 3:1 aspect ratio (0.8 by 2.4 m).

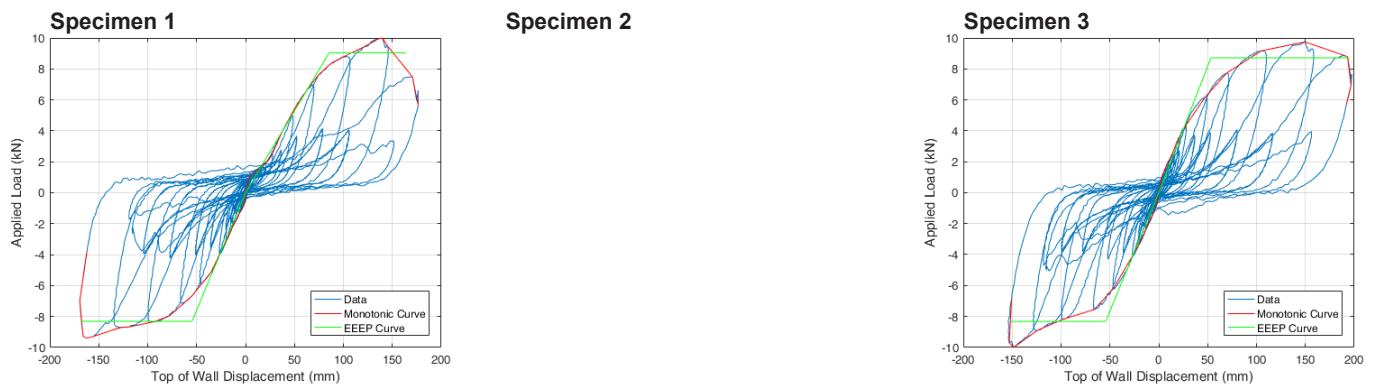

Figure B4. EEEP curves for SIPs with a 4:1 aspect ratio (0.6 by 2.4 m). (Initial misalignment caused pulse displacement in first cycle, which led to unbalanced cyclic loading. No graph provided for Specimen 2.)



### Tests for Single-Panel SIPs without Hold-Downs

**Table B2—EEEP parameters for single-panel SIPs without hold-downs**

Aspect ratio	Specimen number	Positive response						Negative response					
		$P_{yield}$ (kN)	$P_{peak}$ (kN)	$\Delta_{0.4Peak}$ (mm)	$\Delta_{yield}$ (mm)	$\Delta_{peak}$ (mm)	$\Delta_u$ (mm)	$P_{yield}$ (kN)	$P_{peak}$ (kN)	$\Delta_{0.4Peak}$ (mm)	$\Delta_{yield}$ (mm)	$\Delta_{peak}$ (mm)	$\Delta_u$ (mm)
1:1	1	12.94	14.29	1.8	4.2	52.4	54.2	-15.40	-17.22	-1.9	-4.2	-19.1	-45.9
	2	14.05	15.50	2.5	5.7	24.8	44.8	-11.69	-12.70	-2.0	-4.6	-15.2	-23.2
	3 <sup>a</sup>	23.78	23.56	15.2	38.4	63.9	89.3	-18.16	-19.53	-6.7	-15.6	-38.4	-70.7
	Average <sup>b</sup>	13.50	14.90	2.2	4.9	38.6	49.5	-13.55	-14.96	-2.0	-4.4	-17.1	-34.6
2:1	1 <sup>c</sup>	5.74	6.11	5.2	12.2	75.7	96.8	-5.64	-6.42	-7.5	-16.4	-67.4	-92.4
	2	5.00	6.06	3.5	7.3	15.7	21.5	-4.52	-5.06	-1.5	-3.4	-39.5	-62.8
	3 <sup>c</sup>	5.06	5.46	5.5	12.7	52.6	98.9	-5.62	-6.07	-4.8	-11.1	-33.0	-87.7
	Average	5.27	5.88	4.7	10.8	48.0	72.4	-5.26	-5.85	-4.6	-10.3	-46.6	-81.0
3:1	1	3.44	3.75	11.7	26.8	86.0	150.1	-3.19	-3.50	-11.1	-25.3	-84.4	-130.9
	2	3.04	3.28	12.7	29.5	55.3	114.0	-2.89	-3.26	-4.9	-11.0	-38.1	-76.5
	3	3.14	3.46	1.3	2.9	49.4	94.3	-3.01	-3.26	-11.8	-27.3	-76.6	-105.8
	Average	3.21	3.50	8.5	19.7	63.6	119.5	-3.03	-3.34	-9.3	-21.2	-66.4	-104.4
4:1	1 <sup>d</sup>	2.93	3.62	16.1	32.6	143.7	177.3	-3.49	-4.22	-19.5	-40.2	-122.0	-143.4
	2	1.79	2.05	5.2	11.4	22.1	80.1	-1.66	-1.88	-4.7	-10.4	-43.6	-86.1
	3	2.44	2.67	6.2	14.2	102.1	154.1	-2.13	-2.31	-10.0	-22.9	-57.4	-103.7
	Average	2.12	2.36	5.7	12.8	62.1	117.1	-1.89	-2.81	-11.4	-24.5	-74.4	-111.1

<sup>a</sup>Perimeter nail spacing was 102 mm, not the required 152 mm.

<sup>b</sup>Average is for two specimens.

<sup>c</sup>Wall width was 1.12 m, not the required 1.22 m.

<sup>d</sup>Roller that kept load beam alignment restrained lateral movement.

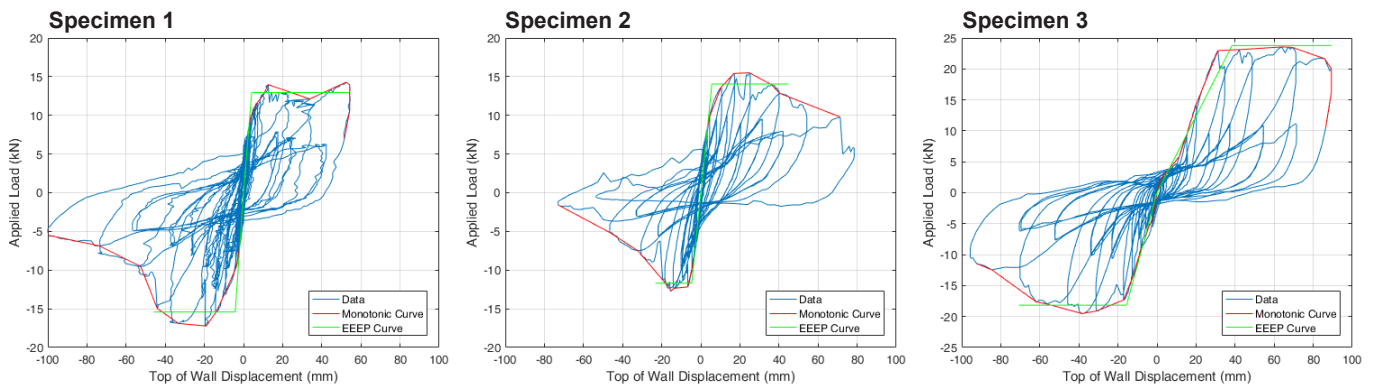

**Figure B5. EEEP curves for SIPs with a 1:1 aspect ratio (2.4 by 2.4 m).**

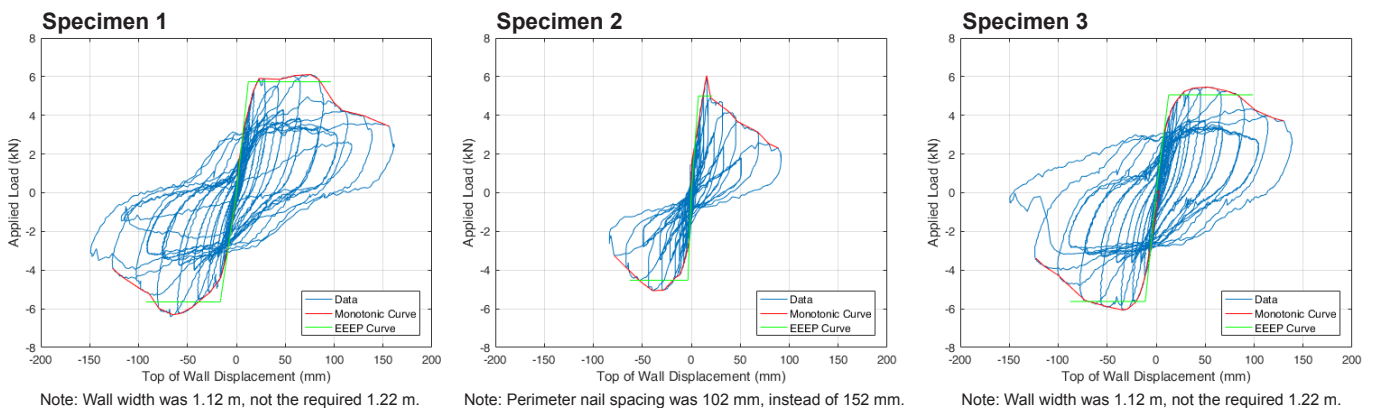

**Figure B6. EEEP curves for SIPs with a 2:1 aspect ratio (1.2 by 2.4 m).**

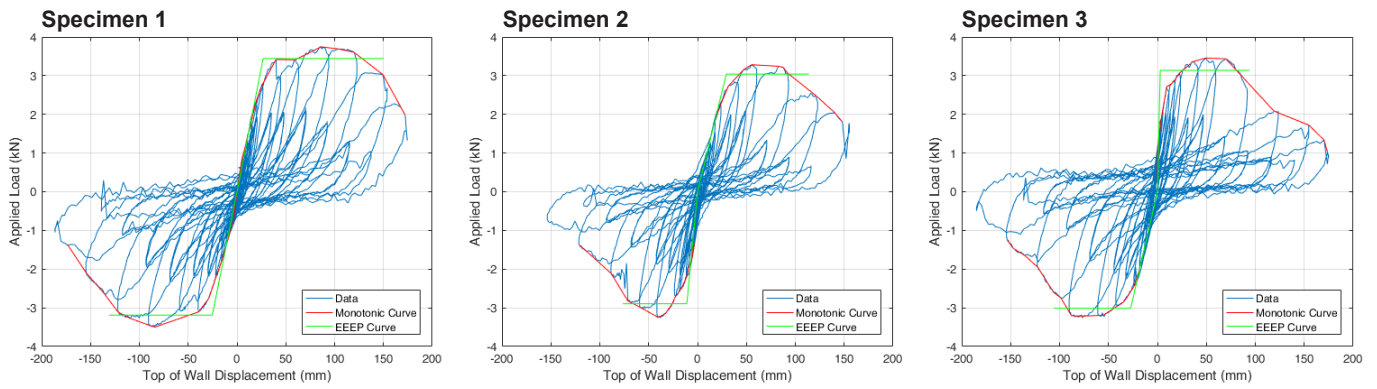

Figure B7. EEEP curves for SIPs with a 3:1 aspect ratio (0.8 by 2.4 m).

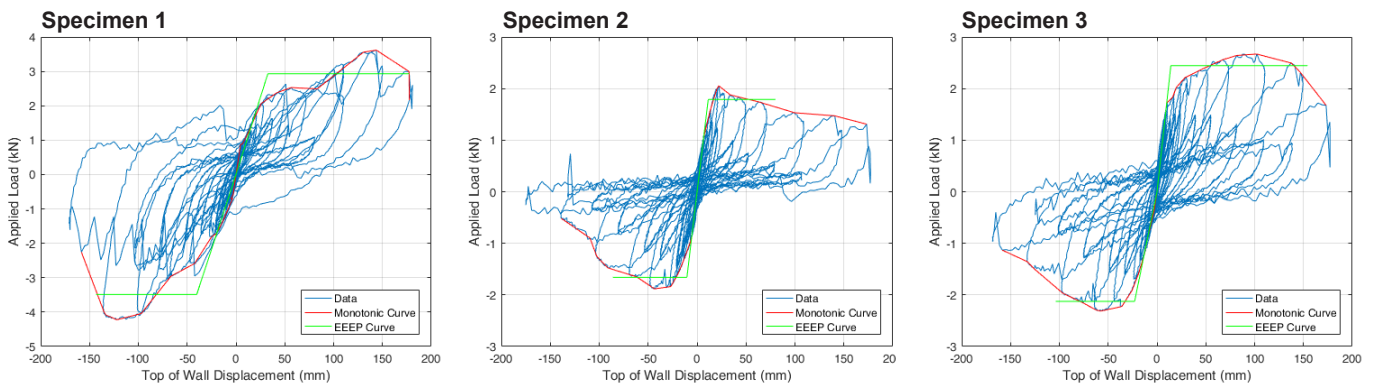

Figure B8. EEEP curves for SIPs with a 4:1 aspect ratio (0.6 by 2.4 m).

### Tests for Multiple-Panel SIPs without Openings

**Table B3—EEEE parameters for multiple-panel SIPs without openings**

Configuration	Specimen number	Positive response						Negative response					
		$P_{yield}$ (kN)	$P_{peak}$ (kN)	$\Delta_{0.4Peak}$ (mm)	$\Delta_{yield}$ (mm)	$\Delta_{peak}$ (mm)	$\Delta_u$ (mm)	$P_{yield}$ (kN)	$P_{peak}$ (kN)	$\Delta_{0.4Peak}$ (mm)	$\Delta_{yield}$ (mm)	$\Delta_{peak}$ (mm)	$\Delta_u$ (mm)
Two panels	1	38.63	43.32	5.6	12.6	44.0	79.4	-36.97	-40.75	-5.5	-12.4	-34.8	-48.1
	2	36.43	40.75	6.2	13.8	44.9	52.0	-35.06	-38.58	-6.7	-15.3	-43.2	-65.6
	3	31.12	36.01	5.9	12.8	43.5	53.1	-40.28	-44.16	-7.9	-17.9	-55.1	-63.7
	Average	35.39	40.03	5.9	13.1	44.1	61.5	-37.44	-41.16	-6.7	-15.2	-44.4	-59.1
Three panels	1	51.51	56.65	6.8	15.5	40.7	68.1	-55.92	-63.41	-6.8	-14.9	-57.0	-71.5
	2	46.02	53.23	4.8	10.3	42.6	46.2	-49.39	-55.72	-5.0	-11.2	-40.8	-58.8
	3 <sup>a</sup>												
	Average	48.77	54.94	5.77	12.89	41.63	57.16	-52.66	-59.57	-5.90	-13.0	-48.9	-65.2
Five panels	1	83.60	92.59	0.8	1.7	40.9	62.7	-74.23	-82.22	-14.2	-32.1	-53.9	-60.1
	2	76.65	85.22	6.0	13.4	61.3	70.0	-79.97	-91.80	-5.5	-12.0	-59.1	-78.2
	3	82.01	90.32	5.9	13.5	61.3	74.4	-85.12	-96.78	-6.2	-13.6	-58.2	-86.3
	Average	80.75	89.38	4.2	9.5	54.5	69.0	-79.77	-90.26	-8.6	-19.2	-57.1	-74.9

<sup>a</sup>Data for Specimen 3 were accidentally compromised and were therefore not included.

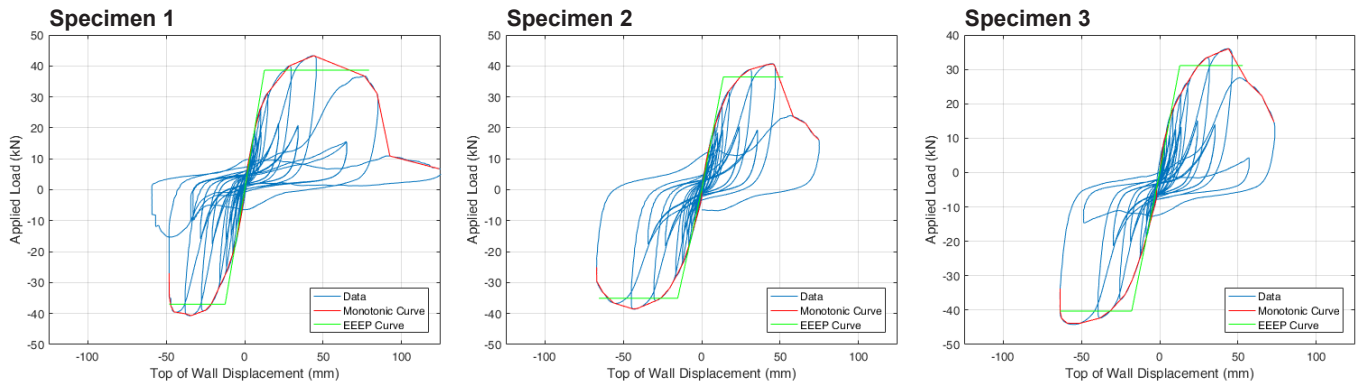

**Figure B9. EEEP curves for two 1.2- by 2.4-m SIP walls.**

Note: Perimeter nail spacing was 102 mm, instead of 152 mm.

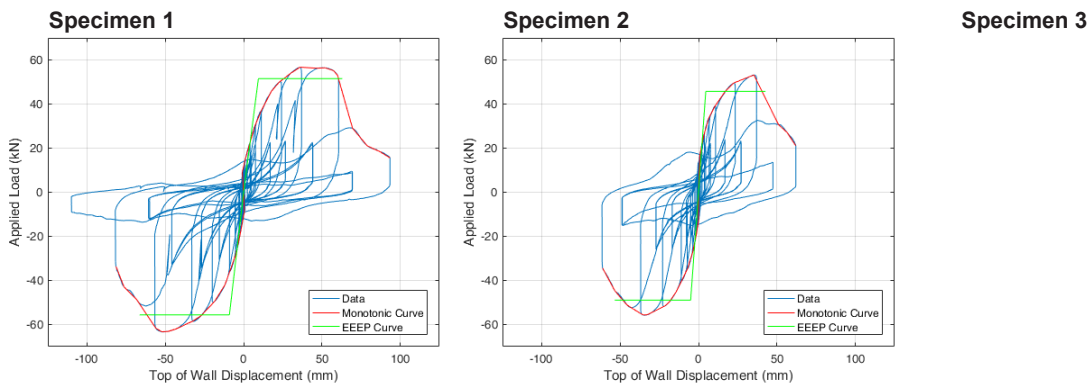

**Figure B10. EEEP curves for three 1.2- by 2.4-m SIP walls (data for Specimen 3 were accidentally compromised and were therefore not included).**



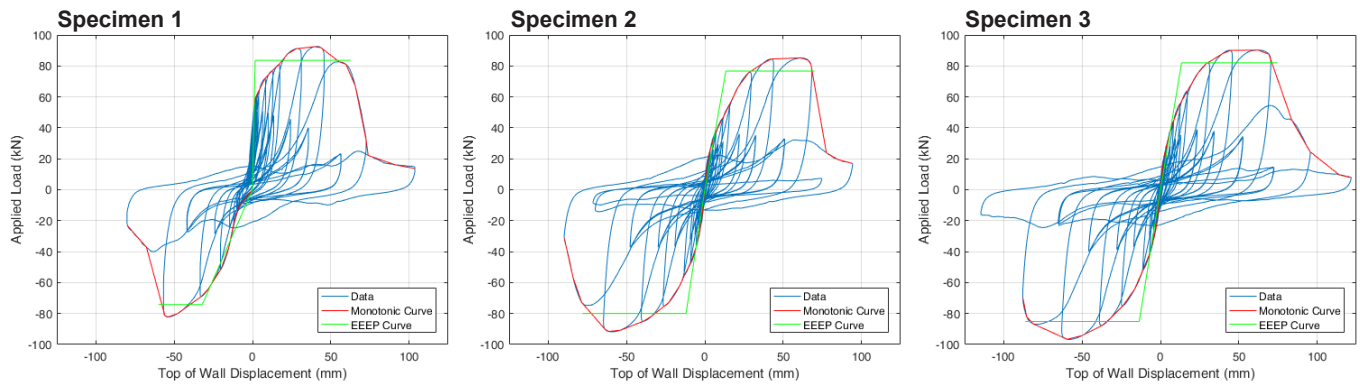
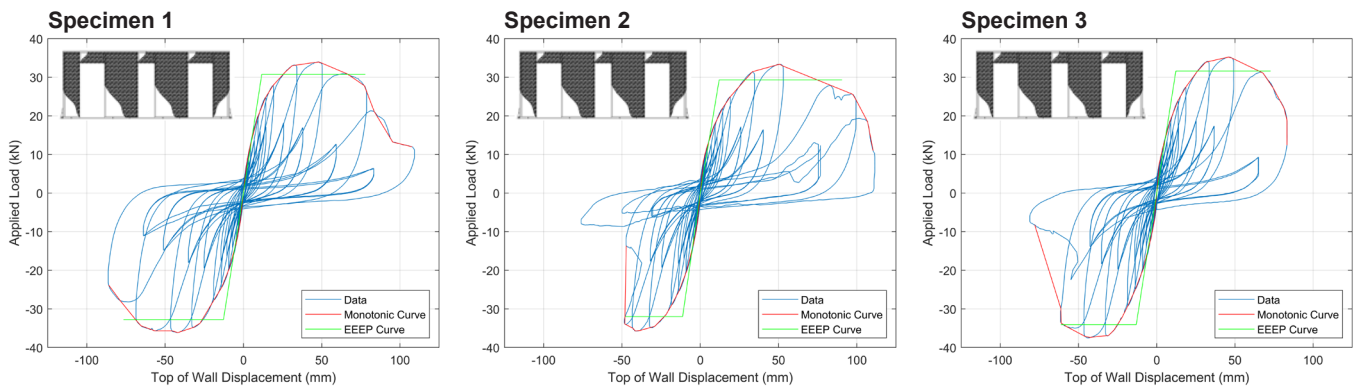

Figure B11. EEEP curves for five 1.2- by 2.4-m SIP walls.

### Tests for Multiple-Panel SIPs with Openings

**Table B4—EEEP parameters for multiple-panel SIPs with openings**

Configuration	Specimen number	Positive response						Negative response					
		$P_{yield}$ (kN)	$P_{peak}$ (kN)	$\Delta_{0.4Peak}$ (mm)	$\Delta_{yield}$ (mm)	$\Delta_{peak}$ (mm)	$\Delta_u$ (mm)	$P_{yield}$ (kN)	$P_{peak}$ (kN)	$\Delta_{0.4Peak}$ (mm)	$\Delta_{yield}$ (mm)	$\Delta_{peak}$ (mm)	$\Delta_u$ (mm)
201	1	30.76	33.99	5.2	11.7	47.9	77.8	-32.77	-36.13	-5.6	-12.8	-41.9	-76.6
	2	29.32	33.40	5.5	12.1	50.7	90.5	-31.99	-35.77	-5.0	-11.2	-40.7	-47.9
	3	31.63	35.23	5.5	12.2	46.0	72.8	-34.07	-37.52	-5.8	-13.1	-44.0	-61.3
	Average	30.57	34.21	5.4	12.0	48.2	80.4	-32.94	-36.47	-5.5	-12.4	-42.2	-61.9
202	1	43.85	48.47	6.9	15.6	63.1	77.9	-42.31	-48.82	-7.3	-15.7	-57.0	-75.3
	2	38.23	42.04	5.9	13.5	58.4	96.9	-33.20	-42.81	-6.5	-12.7	-24.0	-23.4
	3	41.04	46.03	7.8	17.4	47.5	88.9	-40.13	-46.62	-8.1	-17.4	-45.3	-48.8
	Average	41.04	45.51	6.9	15.5	56.3	87.9	-38.54	-46.08	-7.3	-15.3	-42.1	-49.2
203	1	54.09	61.33	6.7	14.8	40.6	53.3	-62.23	-67.95	-6.3	-14.5	-38.3	-78.2
	2	59.71	67.91	4.2	9.2	39.6	73.0	-63.17	-70.24	-4.2	-9.4	-37.0	-55.4
	3	56.03	63.74	4.6	10.2	40.2	57.9	-60.10	-67.39	-5.2	-11.6	-37.5	-57.6
	Average	56.61	64.33	5.2	11.4	40.1	61.4	-61.83	-68.53	-5.2	-11.8	-37.6	-63.7
204	1	38.31	42.64	4.0	8.9	40.7	61.5	-41.26	-44.75	-8.5	-19.6	-39.4	-74.4
	2	38.04	42.18	5.9	13.4	41.9	80.5	-40.45	-45.27	-5.7	-12.6	-34.1	-34.9
	3	42.65	45.62	6.0	13.9	32.9	65.5	-41.08	-48.06	-5.9	-12.6	-27.0	-25.9
	Average	39.67	43.48	5.3	12.1	38.5	69.1	-40.93	-46.03	-6.7	-14.9	-33.5	-45.1
205	1	42.21	46.42	5.9	13.3	41.4	51.6	-47.19	-52.05	-6.6	-14.9	-30.0	-51.1
	2	42.43	47.61	3.9	8.7	29.3	48.6	-46.29	-51.67	-4.3	-9.7	-33.7	-59.8
	3	46.68	51.43	5.1	11.7	44.1	81.2	-43.84	-49.84	-4.9	-10.7	-34.4	-51.6
	Average	43.77	48.49	5.0	11.2	38.3	60.5	-45.77	-51.19	-5.3	-11.8	-32.7	-54.2
206	1	54.78	61.72	2.1	4.7	29.0	46.8	-59.54	-66.09	-8.0	-18.0	-47.5	-73.7
	2	60.72	67.00	5.4	12.3	36.7	82.3	-67.09	-74.10	-6.1	-13.7	-51.2	-65.6
	3	53.24	60.88	4.5	9.8	34.2	49.7	-54.45	-62.83	-4.1	-8.9	-24.6	-50.5
	Average	56.24	63.20	4.0	8.9	33.3	59.6	-60.36	-67.68	-6.1	-13.5	-41.1	-63.2
207	1	32.37	36.22	7.1	15.8	52.4	102.8	-28.58	-31.73	-5.7	-12.9	-29.1	-32.3
	2	25.31	28.76	5.7	12.6	30.8	48.6	-31.80	-35.05	-6.8	-15.5	-44.0	-65.6
	3	27.65	31.24	6.3	14.0	33.8	61.4	-33.31	-36.48	-8.3	-19.0	-34.4	-33.9
	Average	28.45	32.07	6.4	14.1	39.0	70.9	-31.23	-34.42	-7.0	-15.8	-35.8	-43.9



**Figure B12. EEEP curves for 6.04-m SIP walls with openings—configuration 201.**

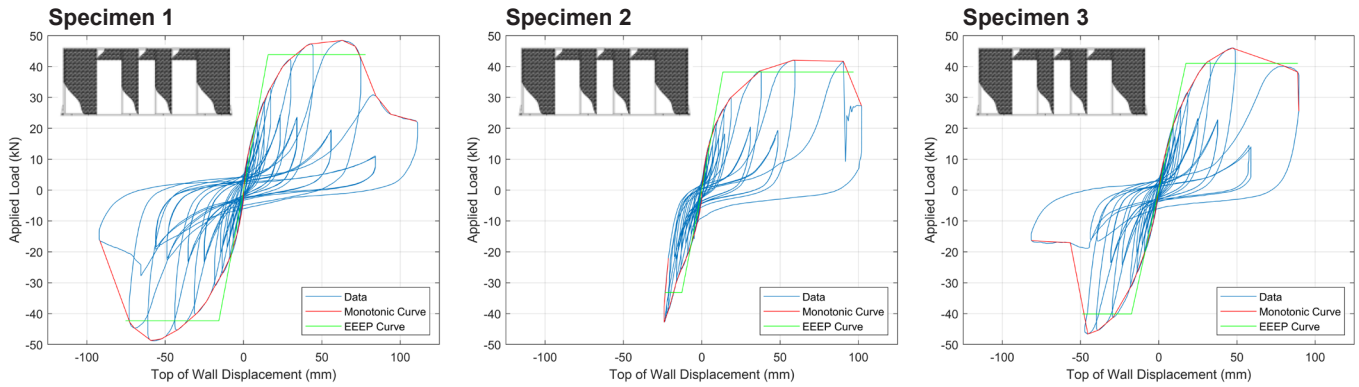

Figure B13. EEEP curves for 6.04-m SIP walls with openings—configuration 202.

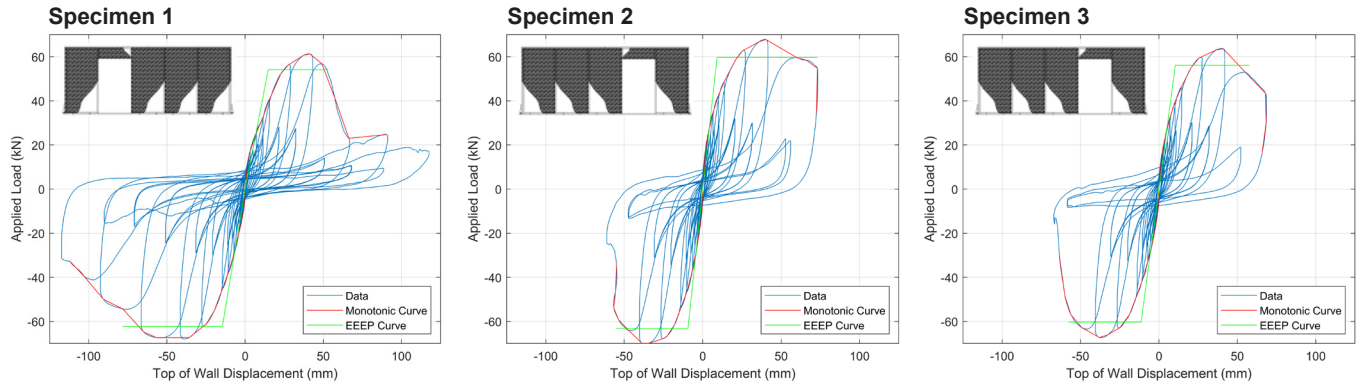

Figure B14. EEEP curves for 6.04-m SIP walls with openings—configuration 203.

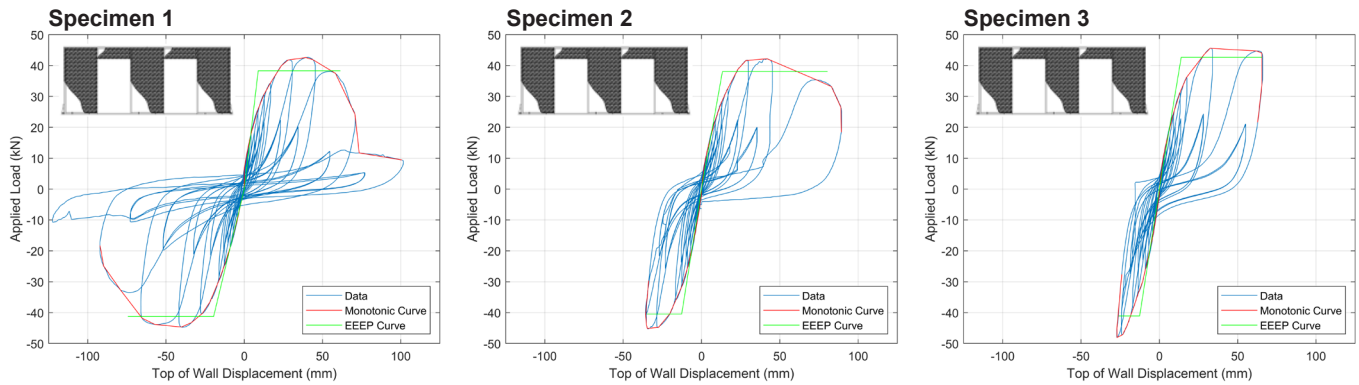

Figure B15. EEEP curves for 6.04-m SIP walls with openings—configuration 204.

Performance of Structural Insulated Panel Walls under Seismic Loading

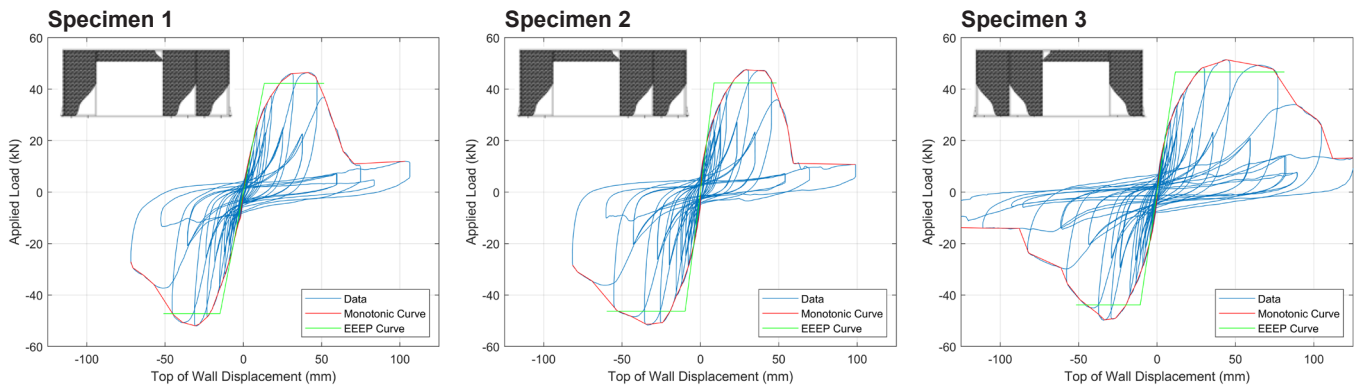

Figure B16. EEEP curves for 6.04-m SIP walls with openings—configuration 205.

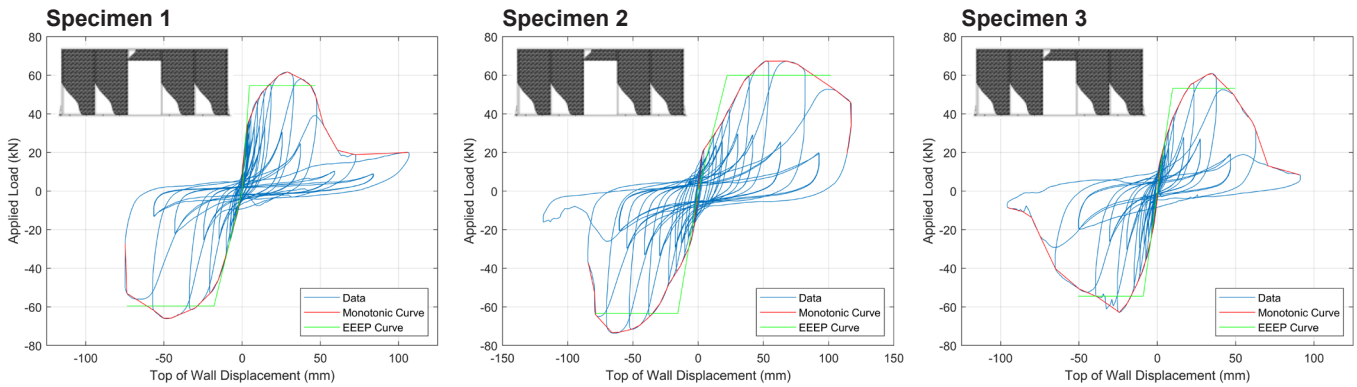

Figure B17. EEEP curves for 6.04-m SIP walls with openings—configuration 206.

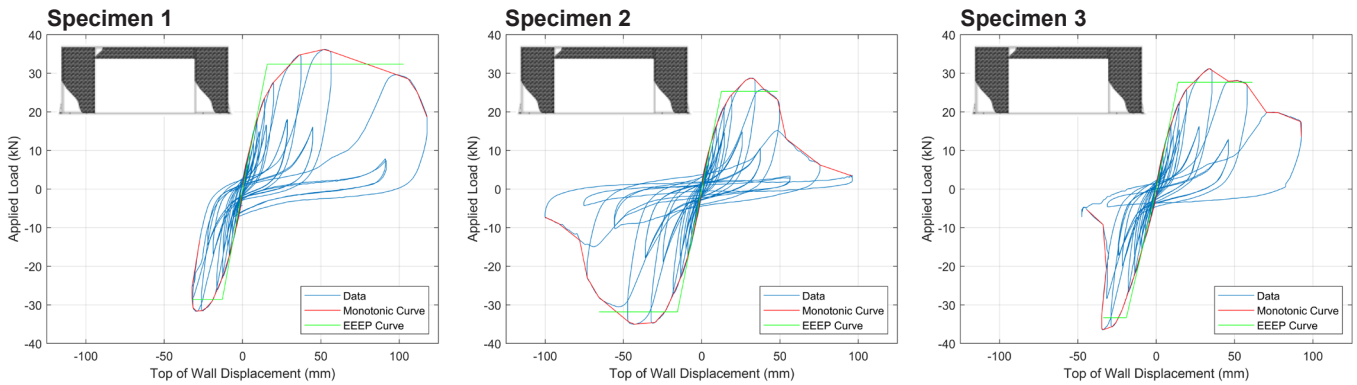

Figure B18. EEEP curves for 6.04-m SIP walls with openings—configuration 207.



# Appendix C—Modified Stewart Parameters for All SIP Configurations

## Tests for Single-Panel SIPs with Hold-Downs

**Table C1—Modified Stewart parameters for single-panel SIPs with hold-downs**

Aspect ratio	Specimen number	$K_o$ (kN/mm)	$r_1$	$r_2$	$r_3$	$r_4$	$F_o$ (kN)	$F_i$ (kN)	$\Delta$ (mm)	$\alpha$	$\beta$
1:1	1	4.765	0.063	-0.104	1.196	0.018	29.16	3.567	43.62	0.55	1.05
	2	2.308	0.017	-0.271	2.624	0.020	49.59	3.708	62.82	0.85	1.10
	3	5.351	0.050	-0.114	1.010	0.003	37.71	2.309	36.92	0.68	1.12
	Average	4.141	0.043	-0.163	1.610	0.014	38.82	3.194	47.78	0.69	1.09
2:1	1	0.732	0.067	-0.128	1.060	0.041	21.14	2.360	57.74	0.75	1.08
	2	1.189	0.127	-0.063	1.010	0.017	13.90	1.871	55.63	0.55	1.09
	3	0.977	0.044	-0.187	1.214	0.022	18.81	2.015	74.82	0.65	1.05
	Average	0.966	0.079	-0.126	1.094	0.027	17.95	2.082	62.73	0.65	1.07
3:1	1	0.399	0.205	-0.195	1.162	0.034	5.29	0.652	92.49	0.25	1.05
	2	0.399	0.024	-0.214	1.181	0.027	12.70	0.933	118.88	0.55	1.05
	3	0.254	0.031	-0.160	1.185	0.033	12.89	0.718	116.80	0.65	1.05
	Average	0.399	0.205	-0.195	1.162	0.034	5.29	0.652	92.49	0.25	1.05
4:1	1	0.171	0.032	-0.574	1.533	0.039	10.01	1.133	141.53	0.55	1.08
	2 <sup>a</sup>	—	—	—	—	—	—	—	—	—	—
	3	0.227	0.050	-0.168	1.247	0.025	7.99	0.581	145.87	0.45	1.05
	Average	0.199	0.041	-0.371	1.390	0.032	9.00	0.857	143.70	0.50	1.07

<sup>a</sup>Initial misalignment caused pulse displacement in first cycle, which led to unbalanced cyclic loading. Data not included in tables.

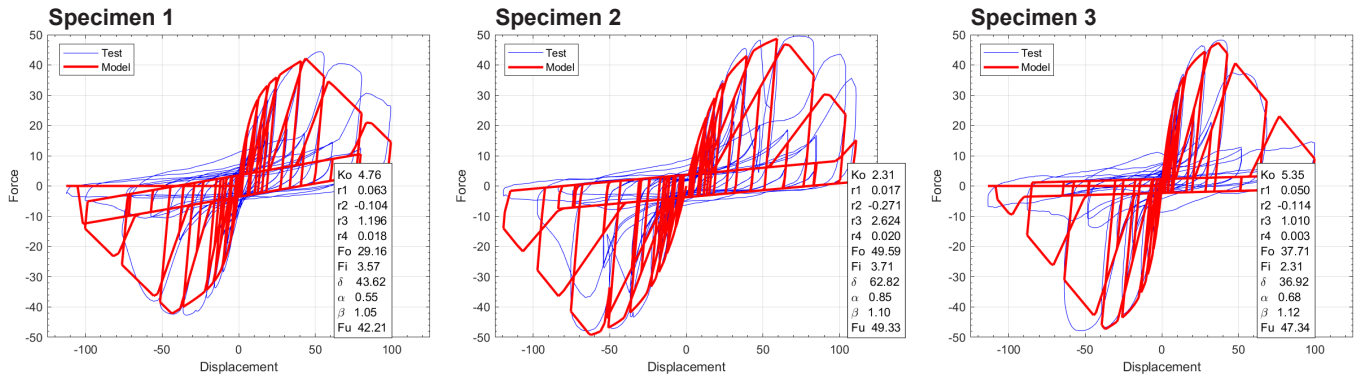

**Figure C1. Modified Stewart curves for SIPs with a 1:1 aspect ratio (2.4 by 2.4 m).**

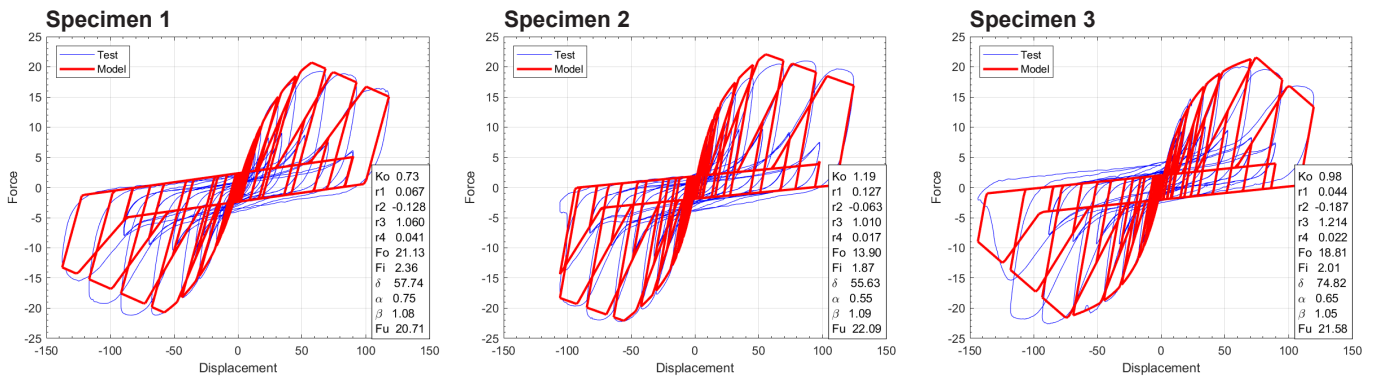

**Figure C2. Modified Stewart curves for SIPs with a 2:1 aspect ratio (1.2 by 2.4 m).**

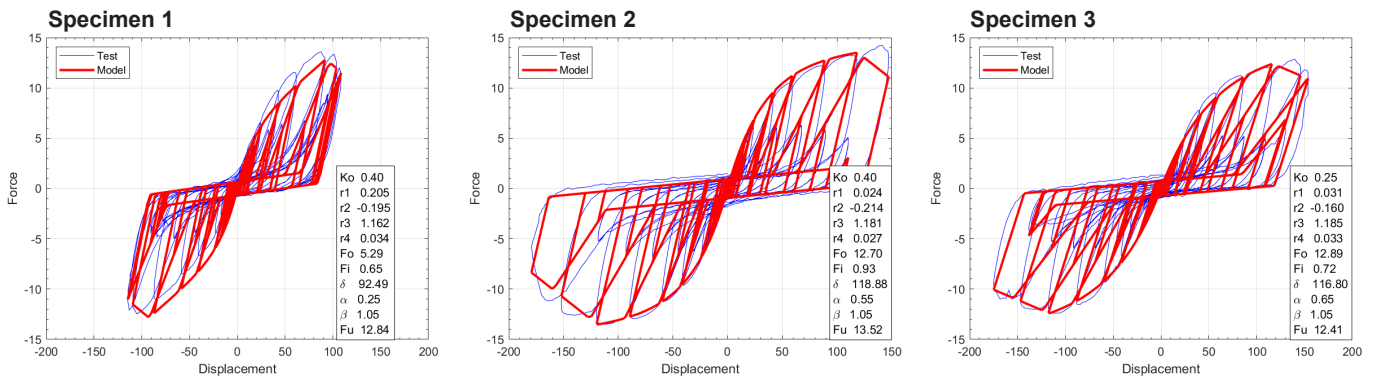

Figure C3. Modified Stewart curves for SIPs with a 3:1 aspect ratio (0.8 by 2.4 m).

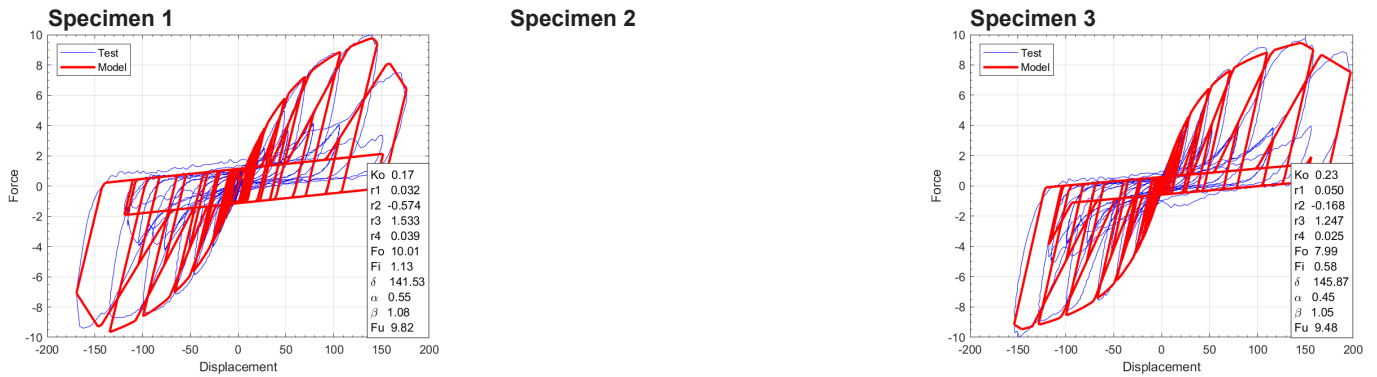

Figure C4. Modified Stewart curves for SIPs with a 4:1 aspect ratio (0.6 by 2.4 m). (Initial misalignment caused pulse displacement in first cycle, which led to unbalanced cyclic loading. No graph provided for Specimen 2.)

### Tests for Single-Panel SIPs without Hold-Downs

Table C2—Modified Stewart parameters for single-panel SIPs without hold-downs

Aspect ratio	Specimen number	$K_0$ (kN/mm)	$r_1$	$r_2$	$r_3$	$r_4$	$F_0$ (kN)	$F_i$ (kN)	$\Delta$ (mm)	$\alpha$	$\beta$
1:1	1	6.555	0.064	-0.028	1.010	0.008	9.09	2.195	21.06	1.00	1.31
	2	4.745	0.041	-0.034	1.010	0.007	11.18	1.272	14.13	1.00	1.11
	3 <sup>a</sup>	1.195	0.021	-0.104	1.568	0.033	23.18	1.801	35.75	1.00	1.13
	Average <sup>b</sup>	5.650	0.052	-0.031	1.010	0.007	10.13	1.733	17.59	1.00	1.21
2:1	1 <sup>c</sup>	0.578	0.032	-0.103	1.010	0.033	5.07	1.261	66.96	1.00	1.00
	2	1.119	0.252	-0.041	1.010	0.015	1.05	0.570	17.19	0.70	1.10
	3 <sup>c</sup>	0.693	0.116	-0.045	1.010	0.028	3.51	1.227	31.56	1.00	1.13
	Average	0.636	0.074	-0.074	1.010	0.030	4.29	1.244	49.26	1.00	1.07
3:1	1	0.189	0.000	-0.124	4.916	0.018	3.49	0.364	94.57	0.76	1.07
	2	0.213	0.004	-0.080	1.010	0.013	3.28	0.226	46.01	0.89	1.02
	3	0.270	0.036	-0.075	1.010	0.018	2.70	0.367	57.50	0.88	1.07
	Average	0.224	0.014	-0.093	2.312	0.016	3.16	0.319	66.03	0.84	1.05
4:1	1 <sup>d</sup>	0.194	0.140	-0.224	1.134	0.018	1.26	0.410	120.10	0.67	1.18
	2	0.256	0.092	-0.036	2.157	0.005	1.23	0.195	28.66	0.95	1.12
	3	0.223	0.042	-0.035	1.010	0.010	1.85	0.255	54.40	0.88	1.00
	Average	0.240	0.067	-0.036	1.584	0.007	1.54	0.225	41.53	0.91	1.06

<sup>a</sup>Perimeter nail spacing was 102 mm, not the required 152 mm.

<sup>b</sup>Average is for two specimens.

<sup>c</sup>Wall width was 1.12 m, not the required 1.22 m.

<sup>d</sup>Roller that kept load beam alignment restrained lateral movement.

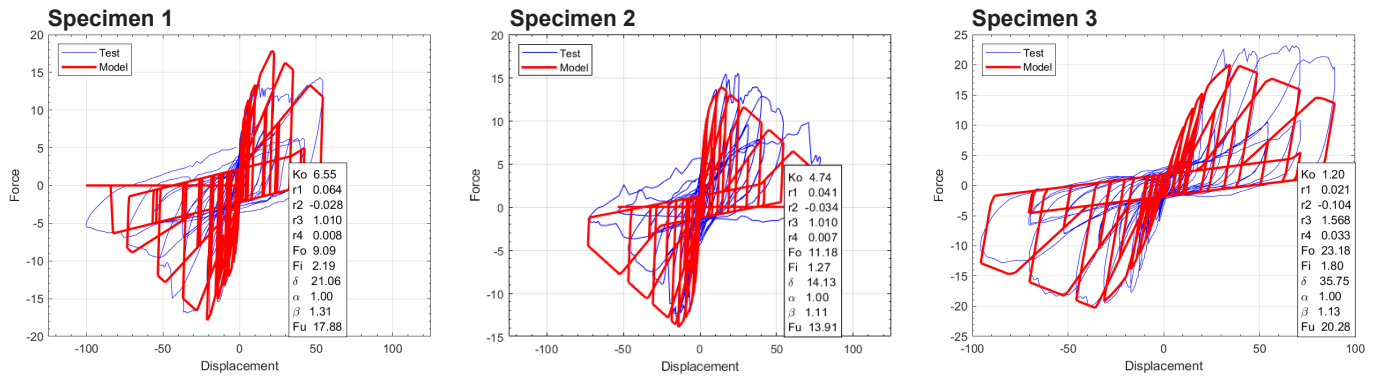

Figure C5. Modified Stewart curves for SIPs with a 1:1 aspect ratio (2.4 by 2.4 m).

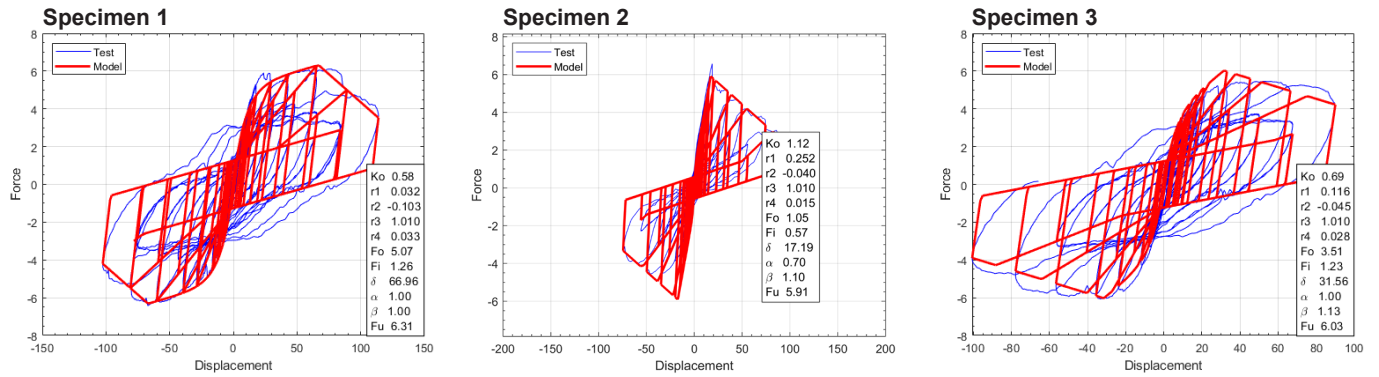

Figure C6. Modified Stewart curves for SIPs with a 2:1 aspect ratio (1.2 by 2.4 m).

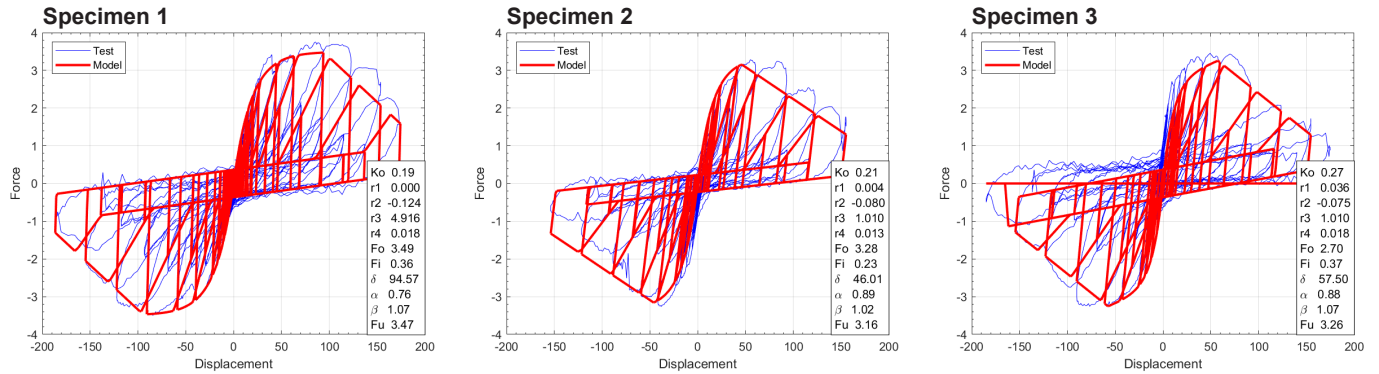

Figure C7. Modified Stewart curves for SIPs with a 3:1 aspect ratio (0.8 by 2.4 m).

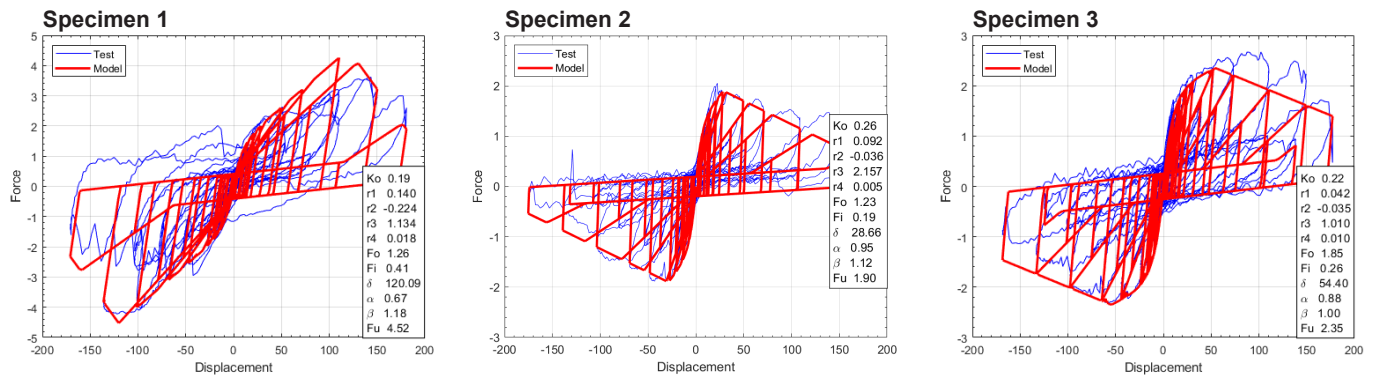

Figure C8. Modified Stewart curves for SIPs with a 4:1 aspect ratio (0.6 by 2.4 m).

### Tests for Multiple-Panel SIPs without Openings

**Table C3—Modified Stewart parameters for multiple-panel SIPs without openings**

Configuration	Specimen number	$K_o$ (kN/mm)	$r_1$	$r_2$	$r_3$	$r_4$	$F_o$ (kN)	$F_i$ (kN)	$\Delta$ (mm)	$\alpha$	$\beta$
Two panels	1	4.082	0.041	-0.056	3.672	0.026	36.26	4.713	41.56	0.65	1.05
	2	3.260	0.018	-0.182	1.010	0.012	37.84	2.680	43.18	0.75	1.10
	3	3.163	0.080	-0.210	1.010	0.010	30.06	2.358	43.99	0.57	1.10
	Average	3.502	0.046	-0.149	1.897	0.016	34.72	3.250	42.91	0.66	1.08
Three panels	1	7.980	0.061	-0.096	1.116	0.006	40.67	5.207	37.34	0.93	1.15
	2	13.669	0.052	-0.095	3.387	0.009	33.64	8.805	34.06	0.65	1.15
	3 <sup>a</sup>	—	—	—	—	—	—	—	—	—	—
	Average	10.825	0.056	-0.096	2.252	0.007	37.16	7.006	35.70	0.791	1.151
Five panels	1	5.512	0.042	-0.385	1.007	0.026	92.59	8.020	42.86	0.90	1.10
	2	8.074	0.069	-0.262	1.010	0.008	61.18	6.203	58.92	0.55	1.05
	3	8.403	0.072	-0.174	1.01	0.008	63.91	6.823	57.27	0.65	1.08
	Average	7.330	0.061	-0.274	1.009	0.014	72.56	7.015	53.01	0.70	1.08

<sup>a</sup>Data for Specimen 3 were accidentally compromised and were therefore not included.

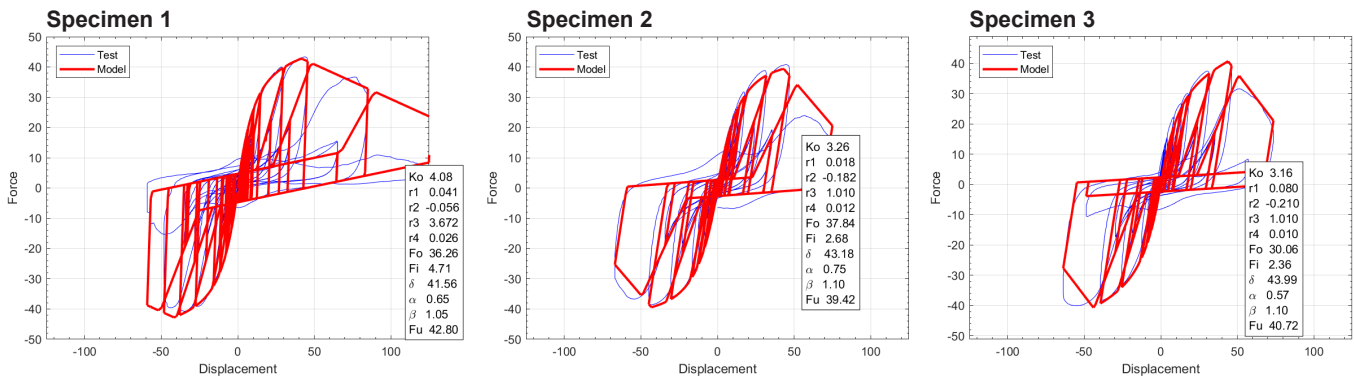

**Figure C9. Modified Stewart curves for SIP walls with two 1.2- by 2.4-m panels.**

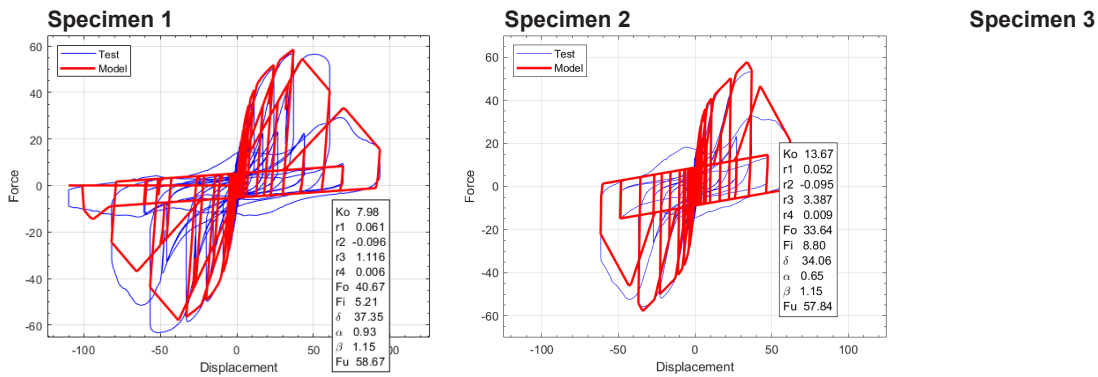

**Figure C10. Modified Stewart curves for SIP walls with three 1.2- by 2.4-m panels (data for Specimen 3 were accidentally compromised and were therefore not included).**



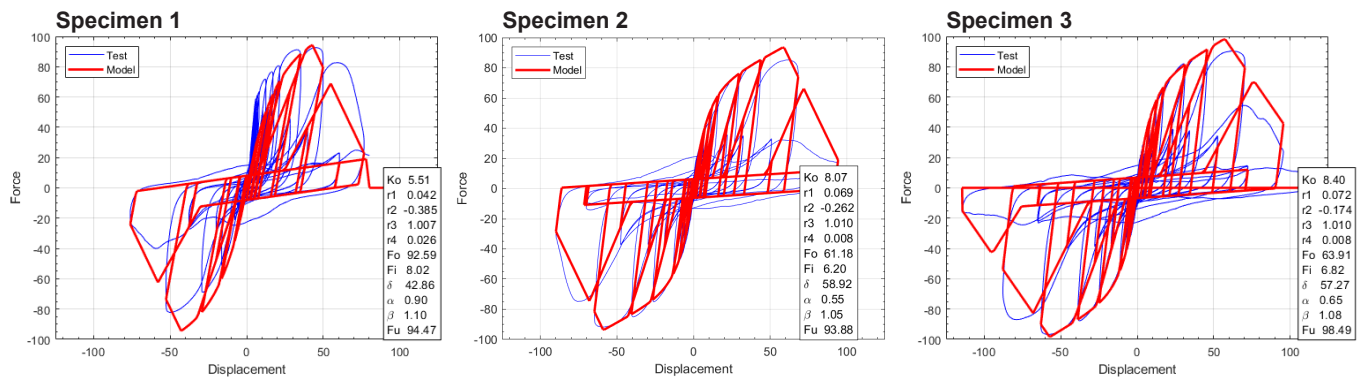

Figure C11. Modified Stewart curves for SIP walls with five 1.2- by 2.4-m panels.

### Tests for Multiple-Panel SIPs with Openings

Table C4—Modified Stewart parameters for multiple-panel SIPs with openings

Configuration	Specimen number	$K_o$ (kN/mm)	$r_1$	$r_2$	$r_3$	$r_4$	$F_o$ (kN)	$F_i$ (kN)	$\Delta$ (mm)	$\alpha$	$\beta$
201	1	3.662	0.085	-0.089	1.010	0.006	23.82	2.154	40.49	0.65	1.05
	2	4.364	0.085	-0.066	1.010	0.021	20.63	2.363	40.00	0.55	1.05
	3	3.608	0.080	-0.157	1.010	0.008	25.60	2.506	41.48	0.75	1.12
	Average	3.878	0.083	-0.104	1.010	0.012	23.35	2.341	40.66	0.65	1.07
202	1	3.769	0.082	-0.197	1.010	0.012	32.25	2.834	56.59	0.48	1.04
	2	3.685	0.000	-0.051	1.010	0.009	38.88	3.200	54.52	0.65	1.15
	3	2.980	0.018	-0.124	1.091	0.045	46.30	3.150	46.25	0.54	1.06
	Average	3.478	0.033	-0.124	1.037	0.022	39.14	3.061	52.45	0.56	1.08
203	1	5.466	0.170	-0.095	2.008	0.015	34.62	4.230	36.85	0.39	1.09
	2	9.338	0.077	-0.092	1.010	0.009	45.51	5.314	31.90	0.58	1.06
	3	7.415	0.095	-0.206	3.004	0.011	43.14	4.984	36.85	0.46	1.01
	Average	7.407	0.114	-0.131	2.007	0.011	41.09	4.843	35.20	0.48	1.05
204	1	3.173	0.028	-0.143	1.010	0.011	44.71	3.074	36.13	0.72	1.06
	2	4.341	0.074	-0.076	1.010	0.034	35.24	3.083	31.84	0.72	1.21
	3	4.300	0.011	-0.029	1.010	0.056	47.52	3.712	30.61	0.66	1.09
	Average	3.938	0.037	-0.083	1.010	0.034	42.49	3.290	32.86	0.70	1.12
205	1	4.191	0.019	-0.135	1.120	0.011	50.36	3.451	33.81	0.84	1.18
	2	6.313	0.085	-0.081	1.010	0.006	34.71	3.441	27.68	0.78	1.16
	3	5.080	0.027	-0.073	1.010	0.009	45.76	3.862	33.32	0.71	1.04
	Average	5.195	0.044	-0.096	1.047	0.009	43.61	3.585	31.60	0.78	1.13
206	1	7.477	0.039	-0.055	1.010	0.009	52.83	4.283	28.84	0.55	1.00
	2	4.728	0.073	-0.100	1.010	0.011	55.28	5.388	42.67	0.70	1.15
	3	8.721	0.174	-0.090	1.010	0.017	28.30	4.621	23.41	0.52	1.12
	Average	6.975	0.095	-0.082	1.010	0.013	45.47	4.764	31.64	0.59	1.09
207	1	2.864	0.014	-0.048	1.010	0.011	34.36	2.909	29.29	0.73	1.09
	2	2.629	0.018	-0.153	1.147	0.016	35.03	2.310	28.91	0.72	1.00
	3	2.493	0.016	-0.130	1.010	0.012	36.47	2.850	27.91	0.98	1.12
	Average	2.662	0.016	-0.111	1.056	0.013	35.28	2.690	28.70	0.81	1.07

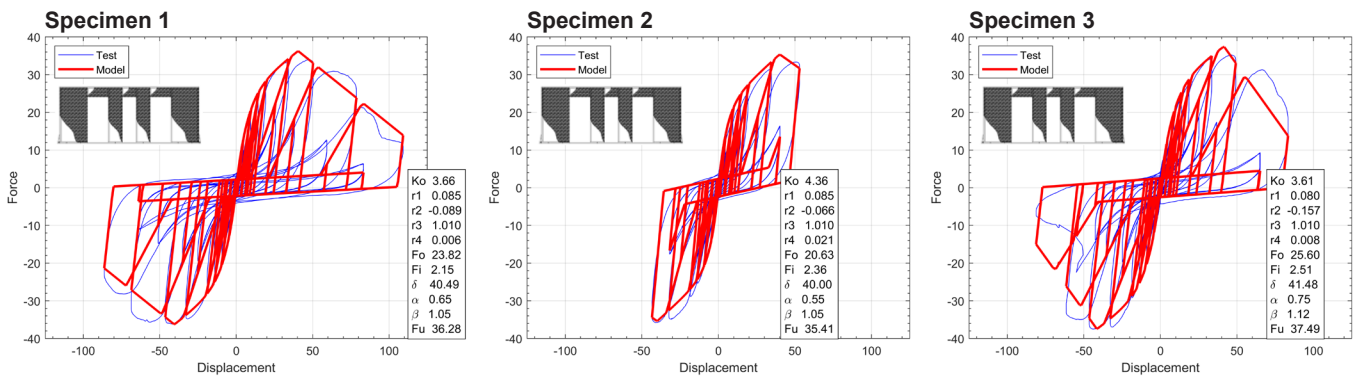

Figure C12. Modified Stewart curves for 6.04-m SIP walls with openings—configuration 201.

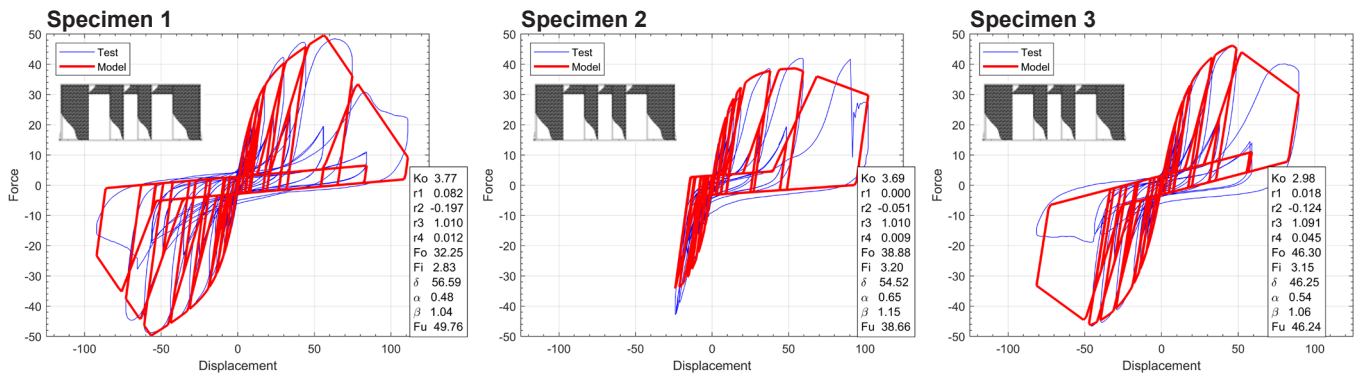

Figure C13. Modified Stewart curves for 6.04-m SIP walls with openings—configuration 202.

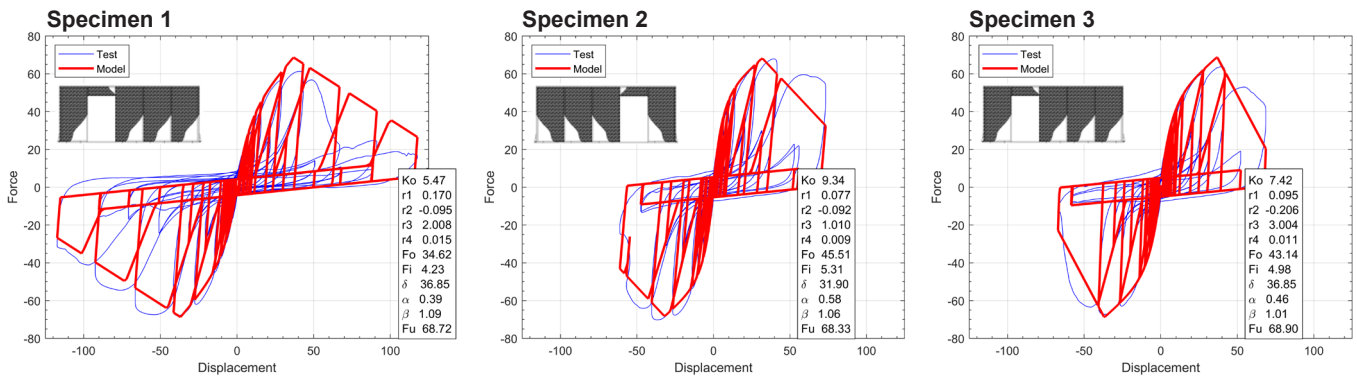

Figure C14. Modified Stewart curves for 6.04-m SIP walls with openings—configuration 203.

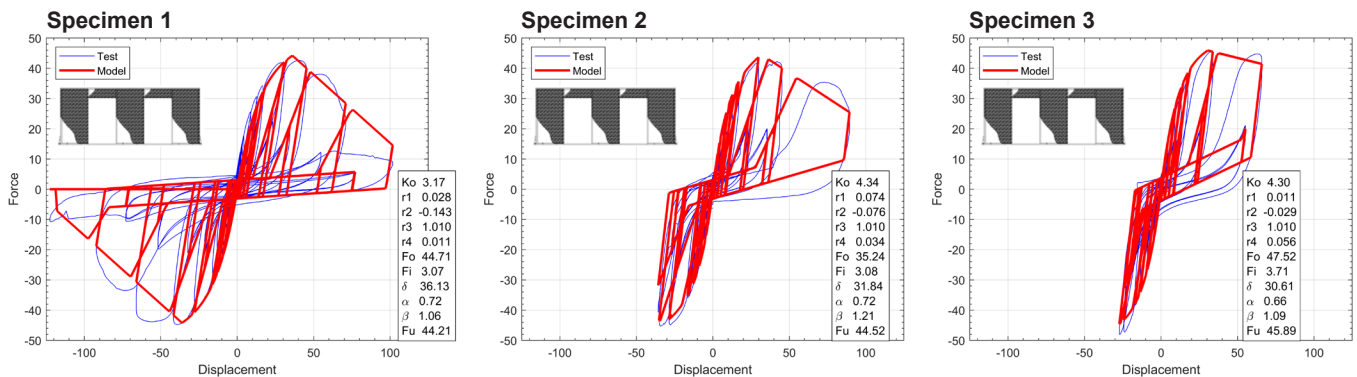

Figure C15. Modified Stewart curves for 6.04-m SIP walls with openings—configuration 204.

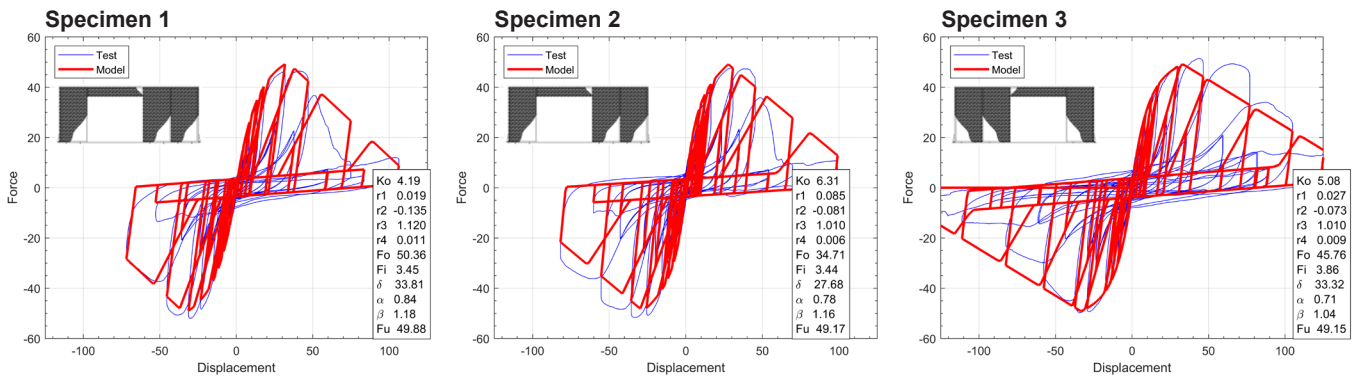

Figure C16. Modified Stewart curves for 6.04-m SIP walls with openings—configuration 205.

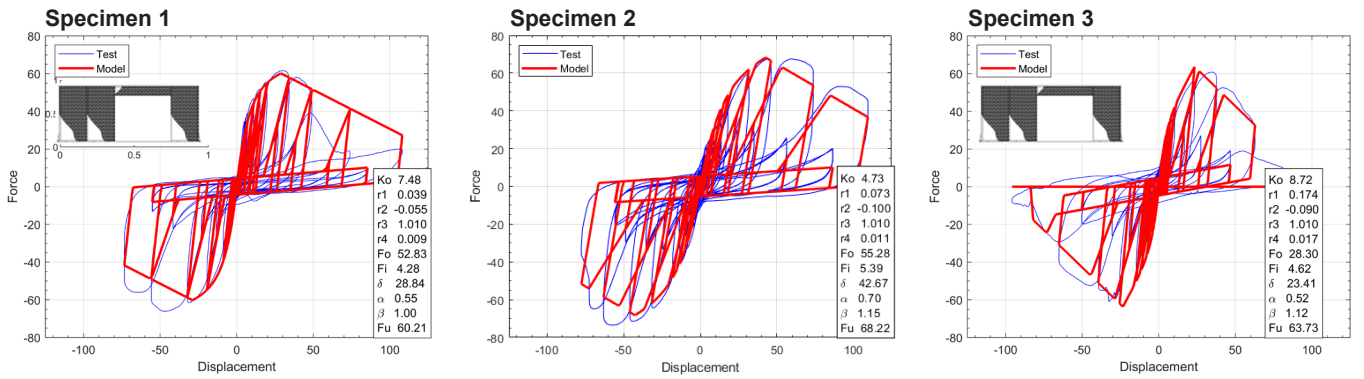

Figure C17. Modified Stewart curves for 6.04-m SIP walls with openings—configuration 206.

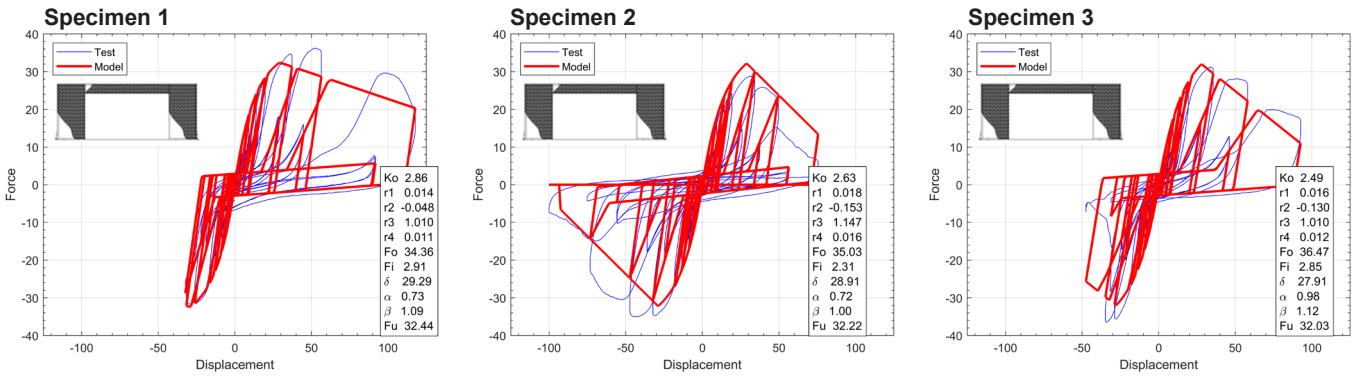

Figure C18. Modified Stewart curves for 6.04-m SIP walls with openings—configuration 207.

## Appendix D—Hold-Down Forces Relative to Applied Load for Configurations with Hold-Downs

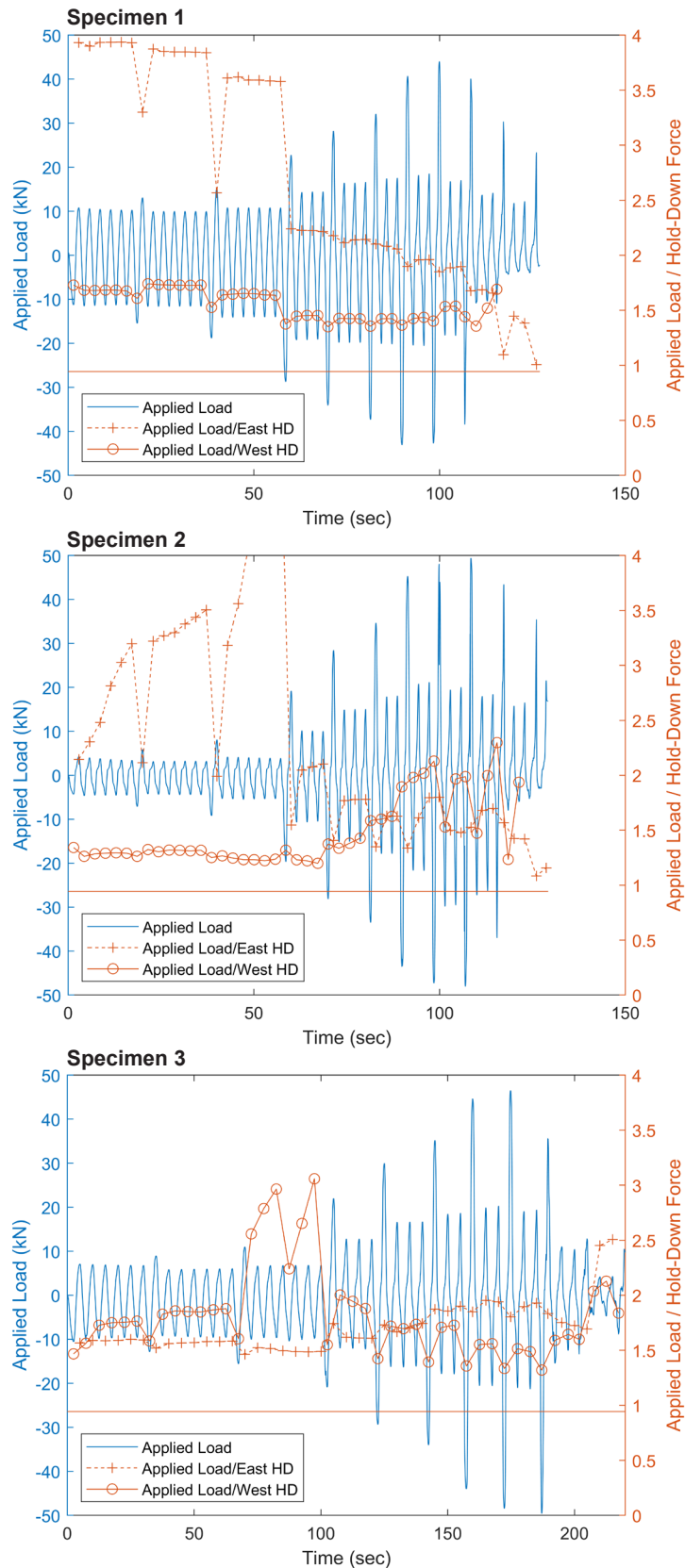

Figure D1. Ratios of applied load to hold-down force for single-panel SIPs with 1:1 aspect ratio.



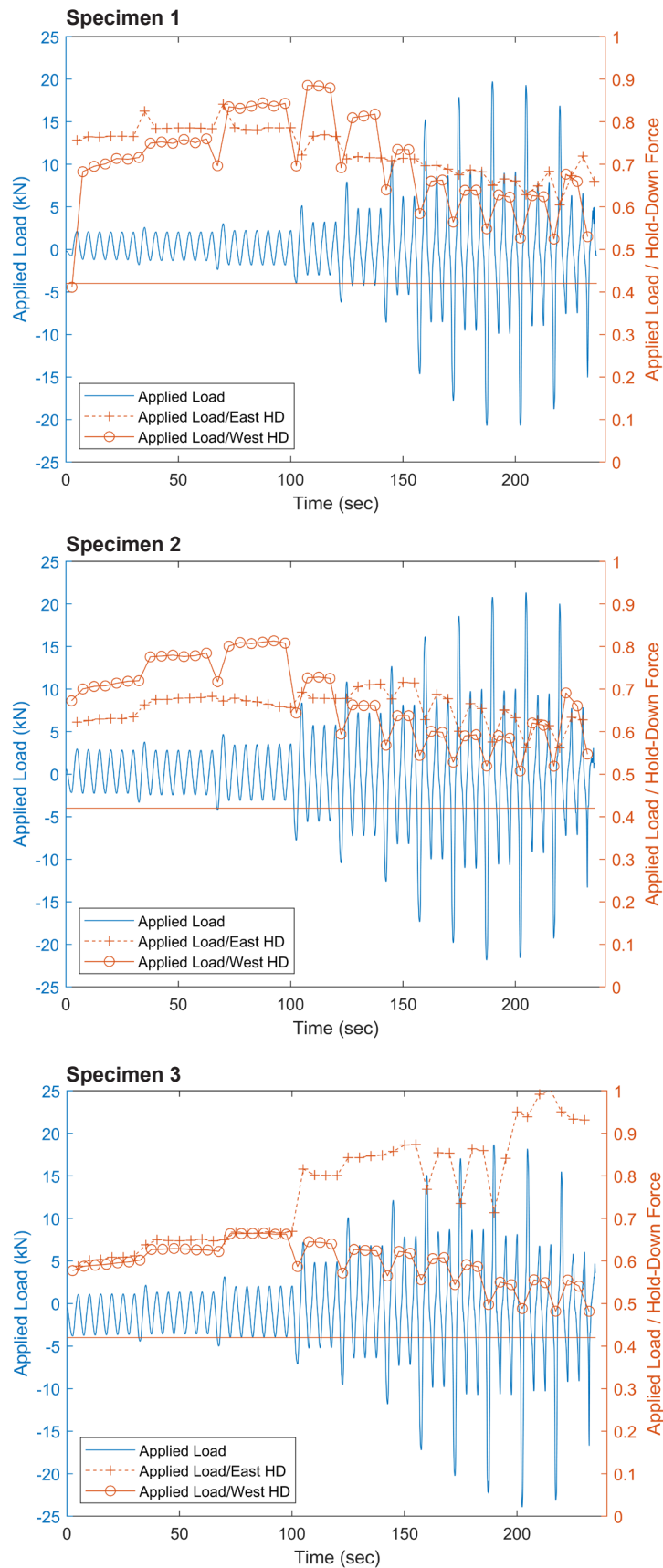

Figure D2. Ratios of applied load to hold-down force for single-panel SIPs with 2:1 aspect ratio.

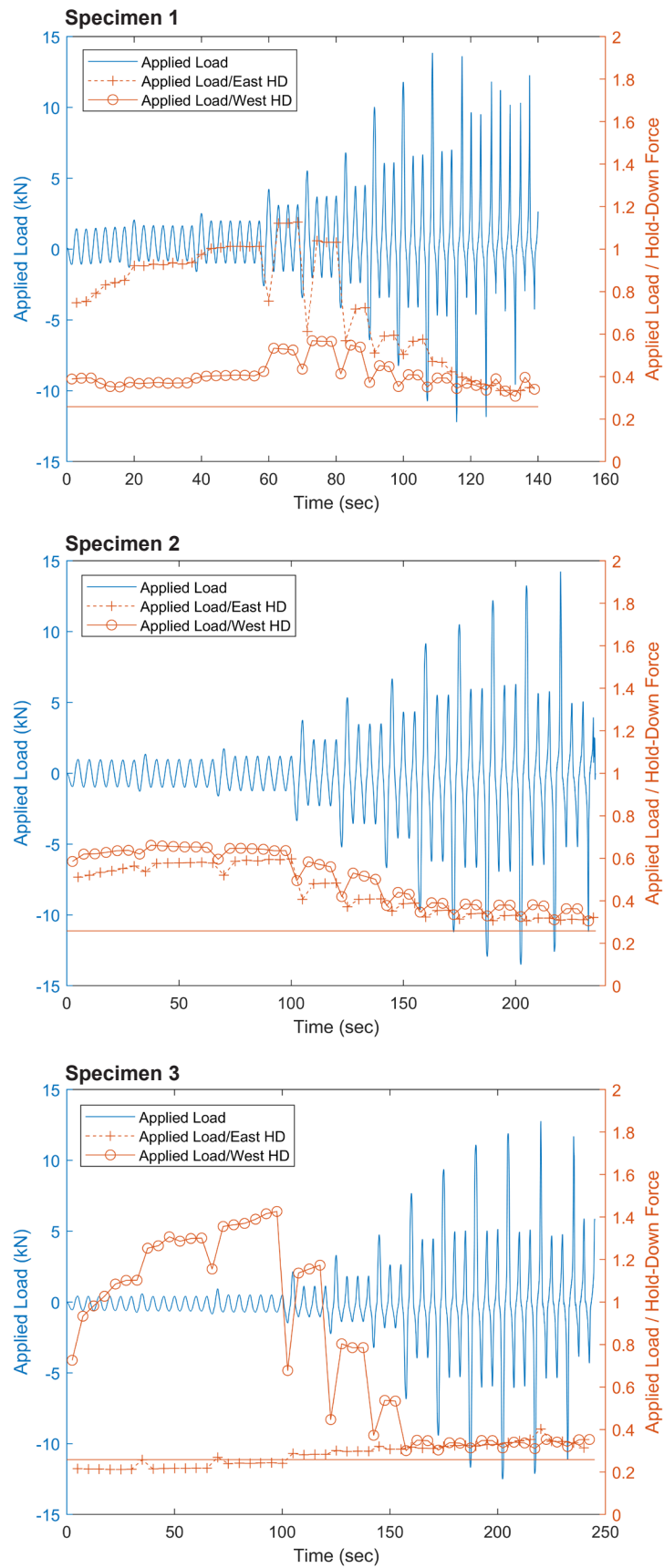
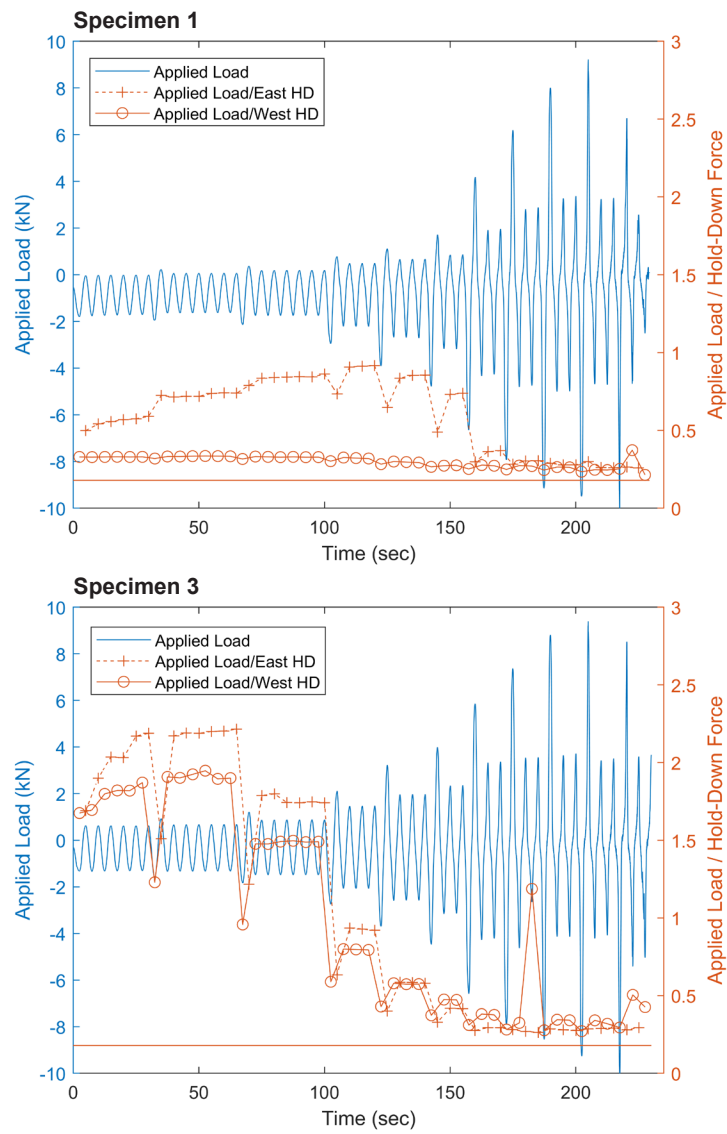

Figure D3. Ratios of applied load to hold-down force for single-panel SIPs with 3:1 aspect ratio.



**Figure D4. Ratios of applied load to hold-down force for single-panel SIPs with 4:1 aspect ratio.**

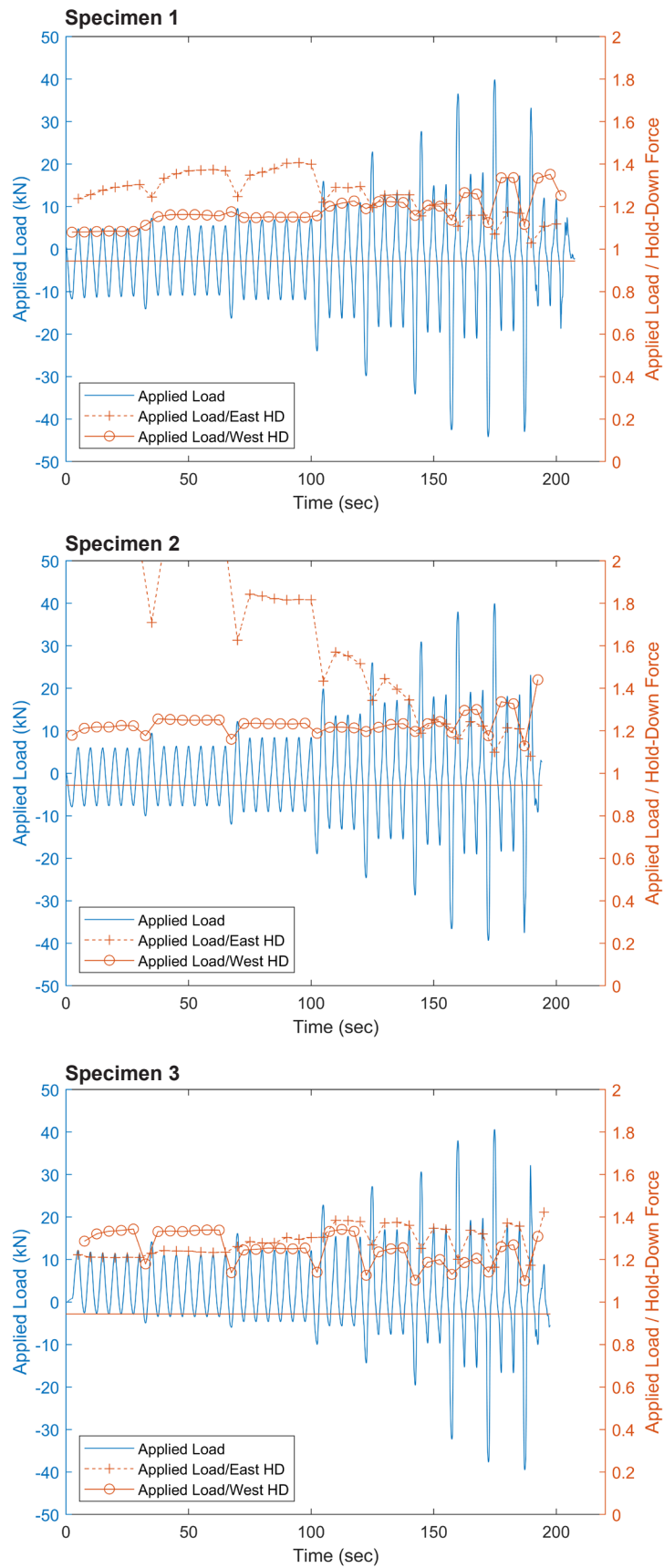

Figure D5. Ratios of applied load to hold-down force for multiple-panel SIPs without openings: two panels.



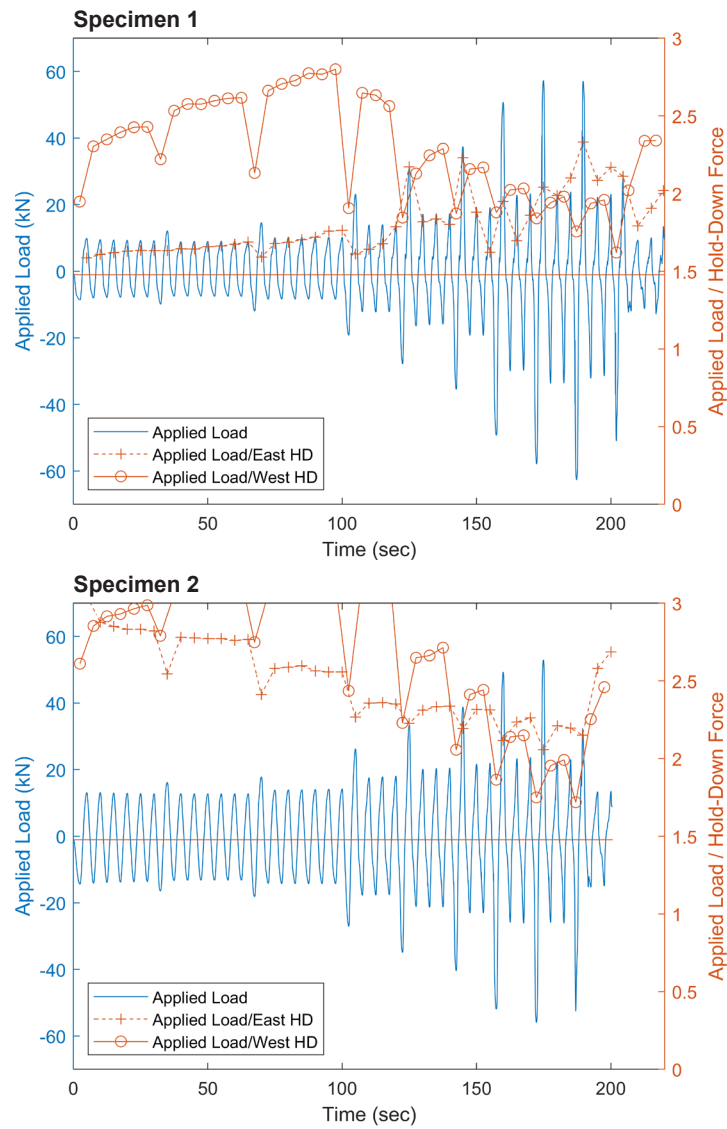
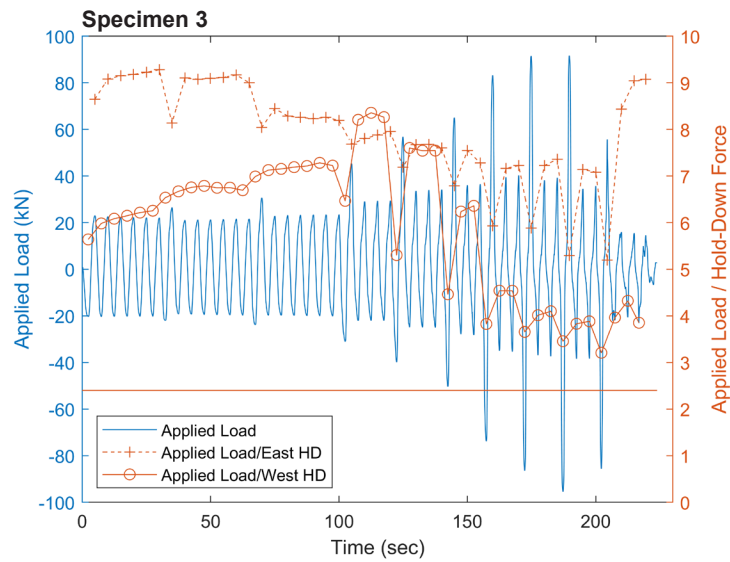
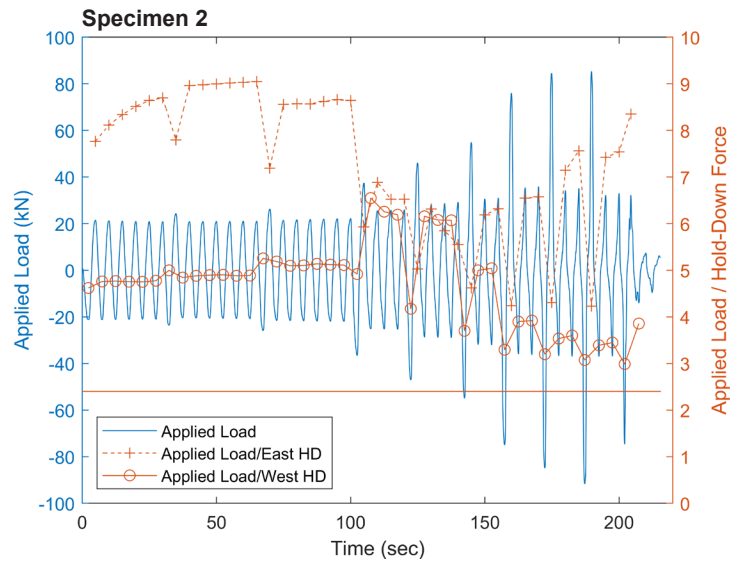

Figure D6. Ratios of applied load to hold-down force for multiple-panel SIPs without openings: three panels.

**Specimen 1**

Faulty load cell connection during test.



**Figure D7. Ratios of applied load to hold-down force for multiple-panel SIPs without openings: five panels.**

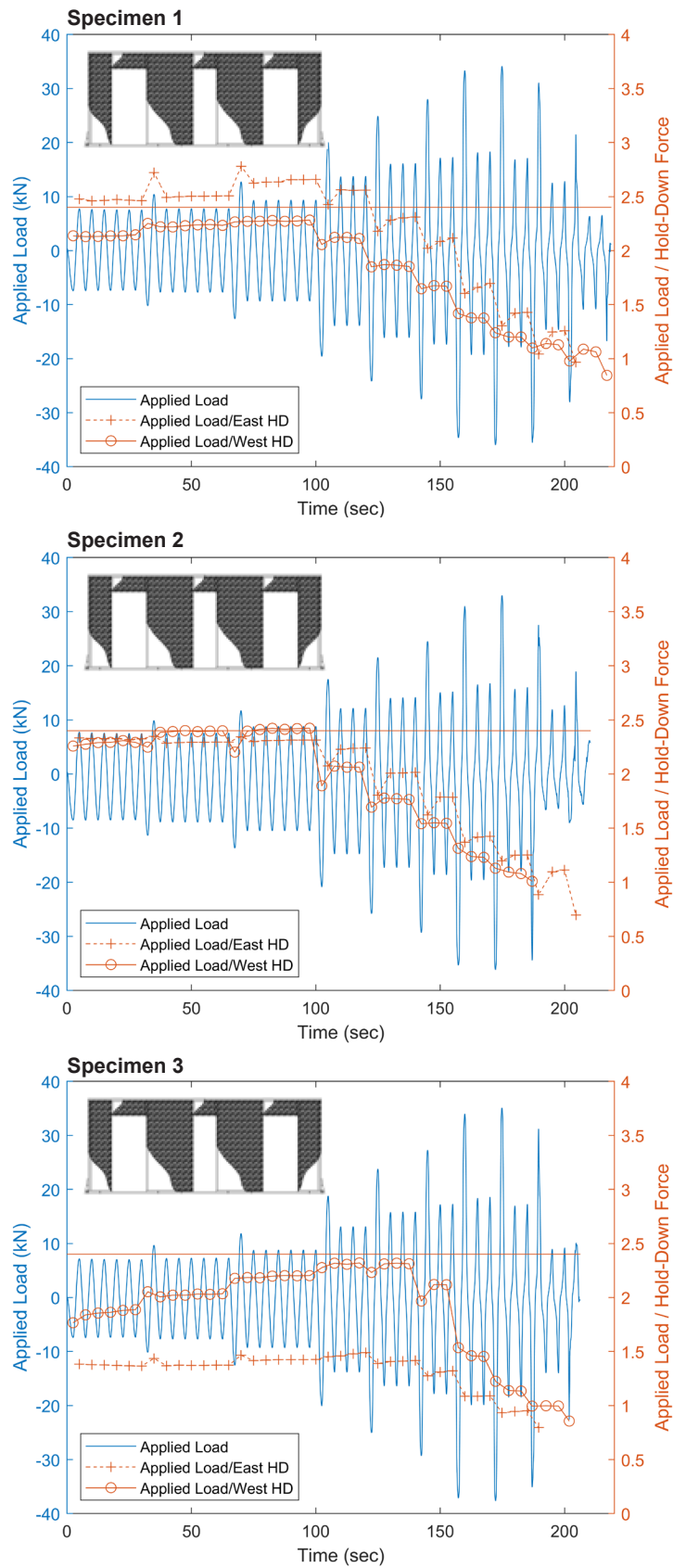

Figure D8. Ratios of applied load to hold-down force for multiple-panel SIPs with openings: Configuration 201.

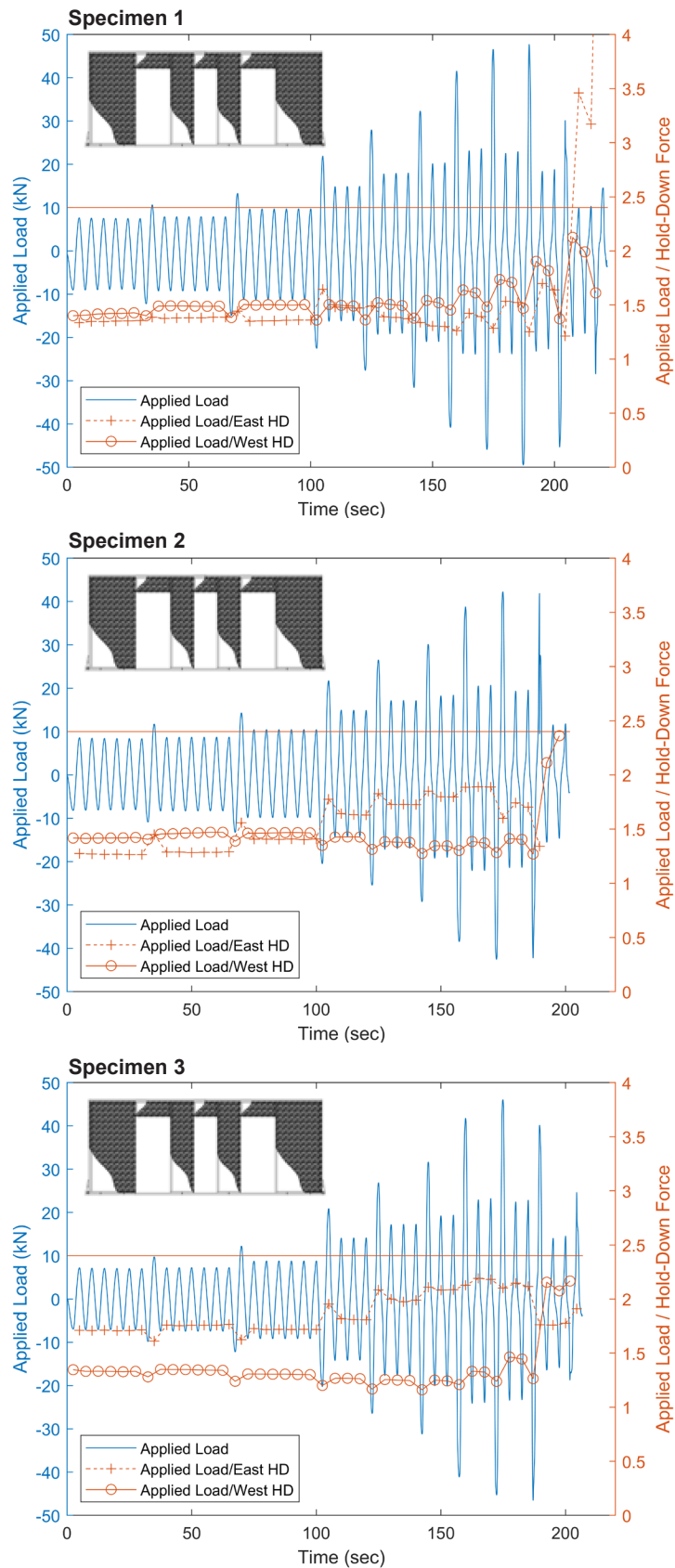

Figure D9. Ratios of applied load to hold-down force for multiple-panel SIPs with openings: Configuration 202.



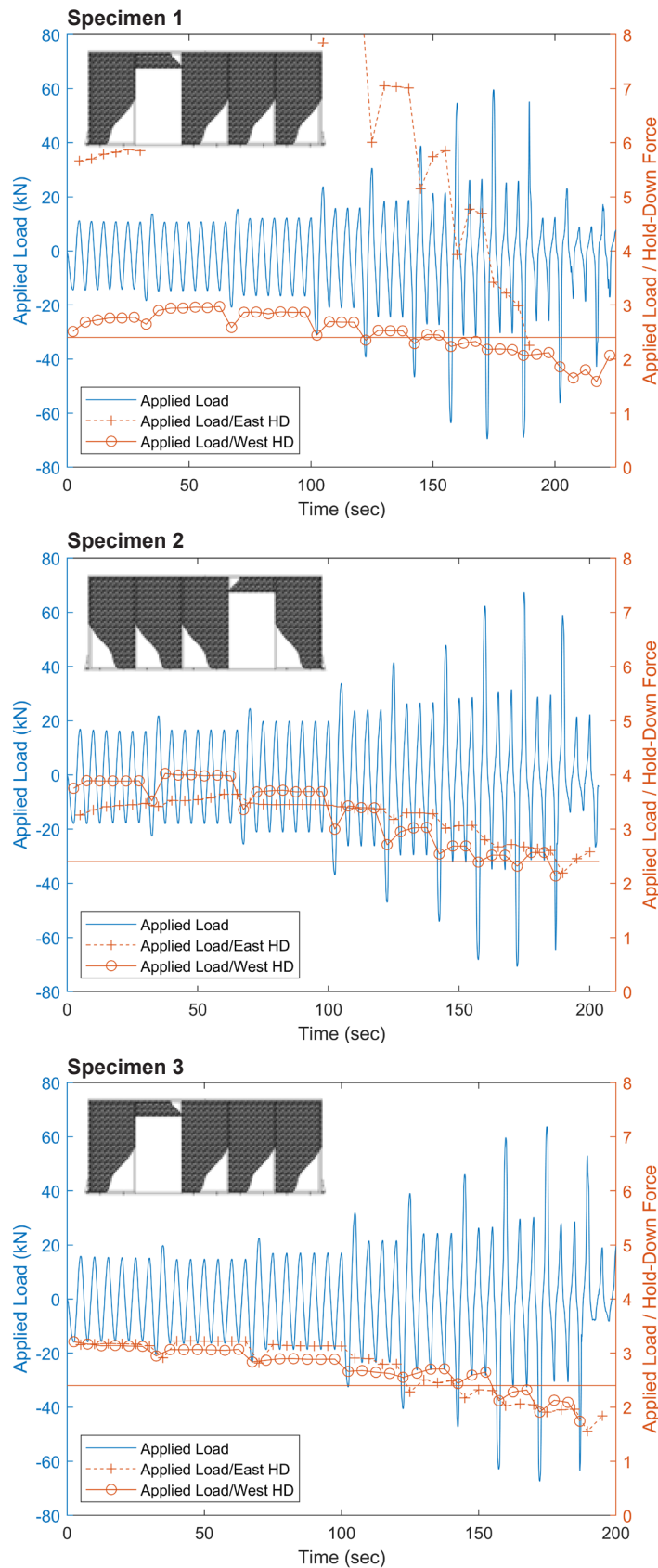

Figure D10. Ratios of applied load to hold-down force for multiple-panel SIPs with openings: Configuration 203.

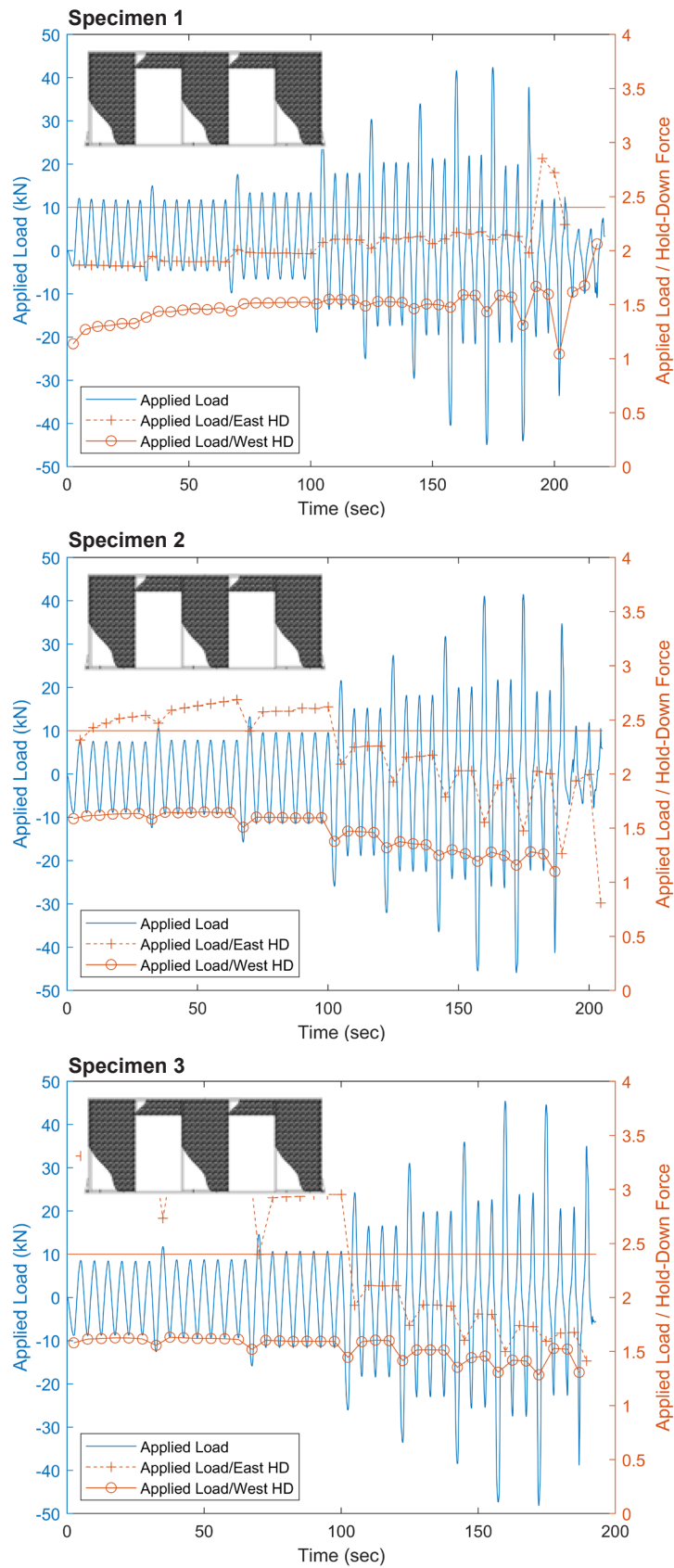

Figure D11. Ratios of applied load to hold-down force for multiple-panel SIPs with openings: Configuration 204.

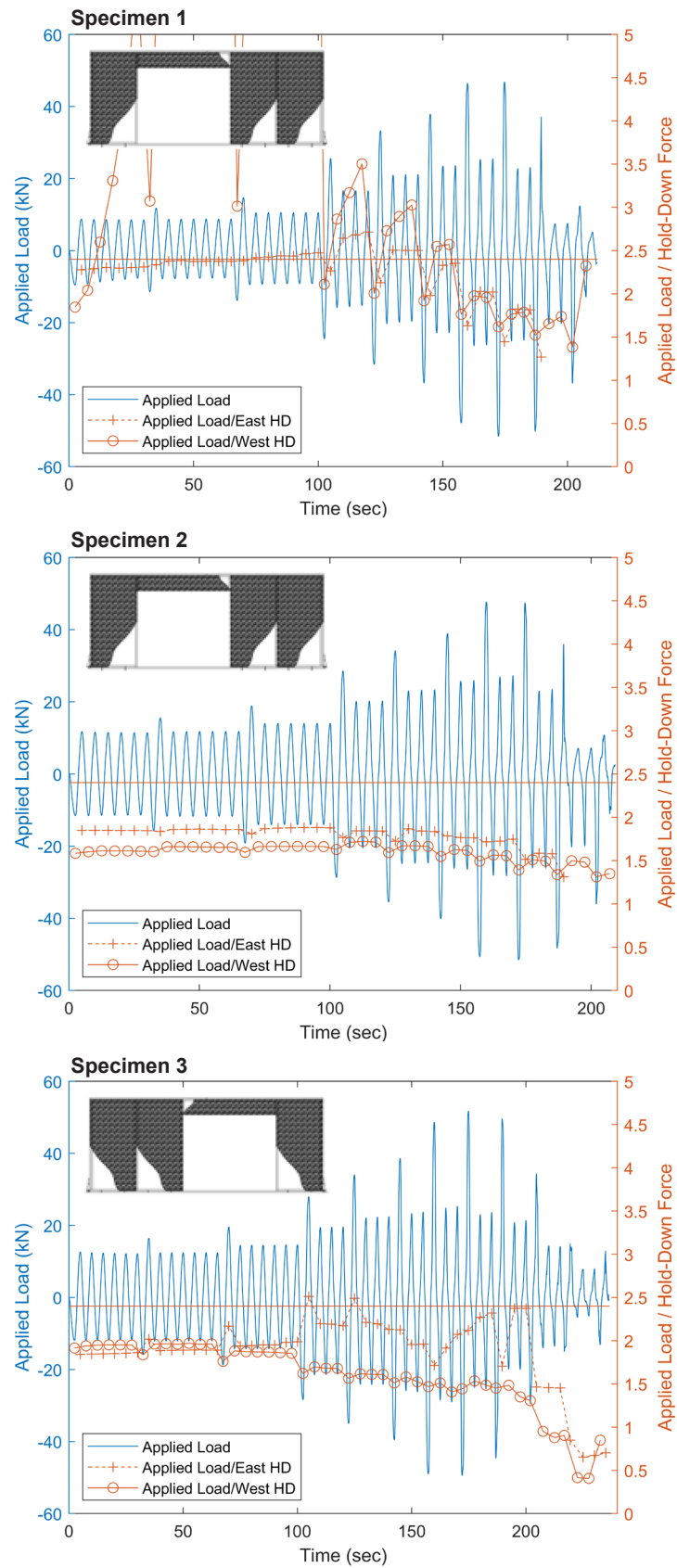

Figure D12. Ratios of applied load to hold-down force for multiple-panel SIPs with openings: Configuration 205.

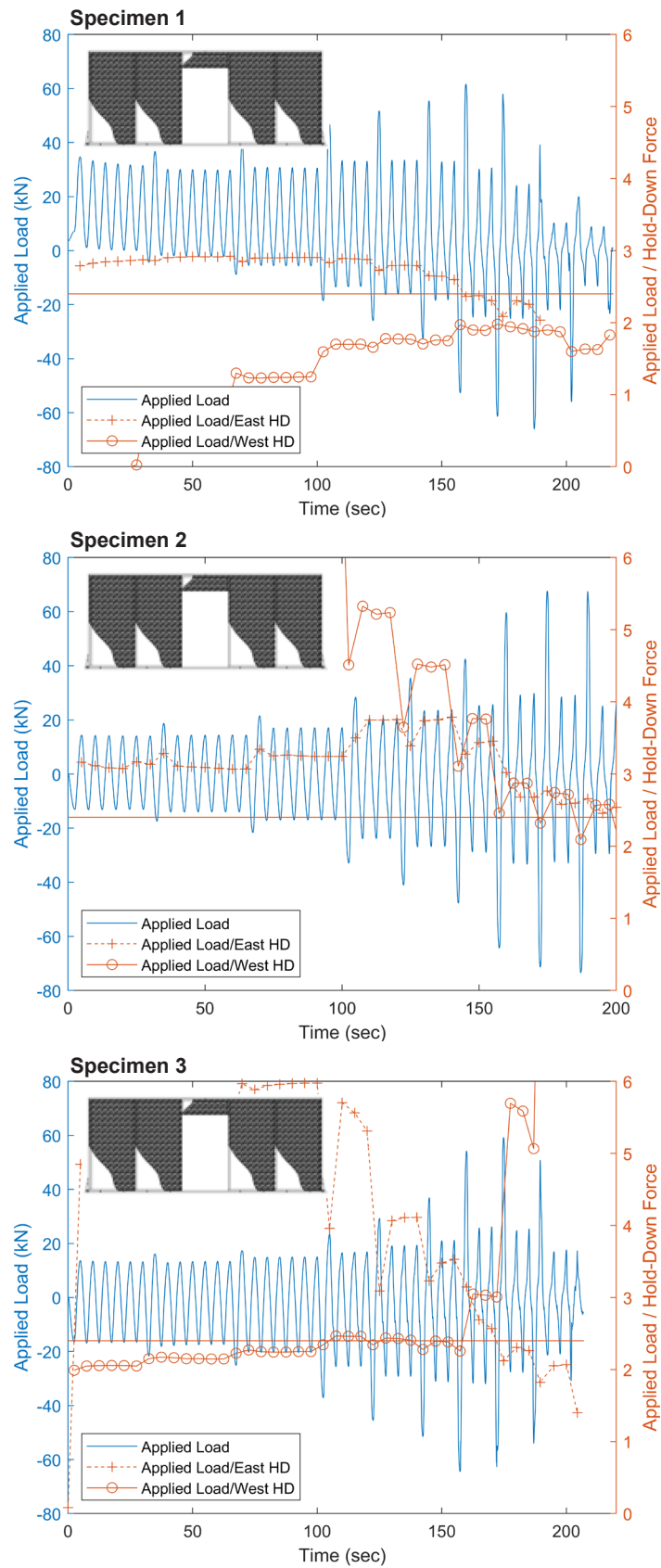

Figure D13. Ratios of applied load to hold-down force for multiple-panel SIPs with openings: Configuration 206.



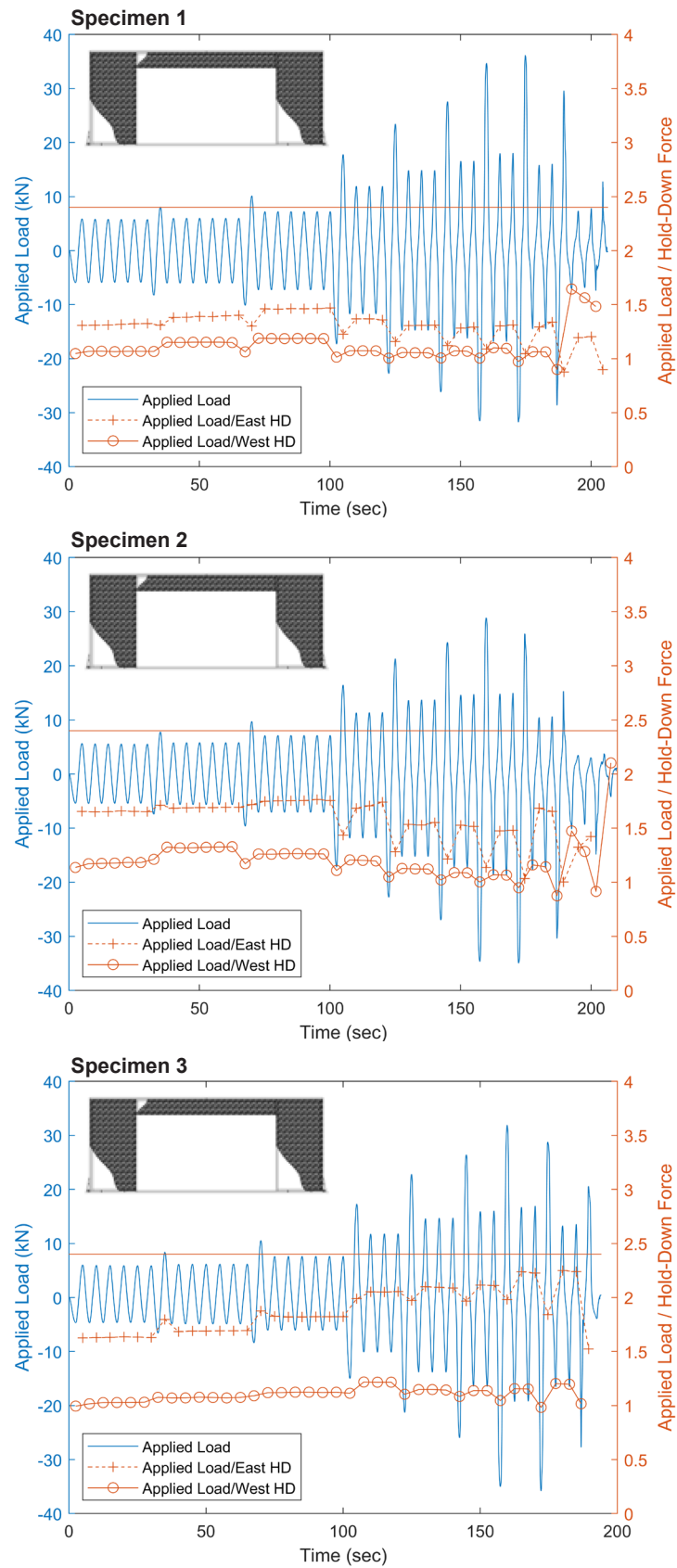

Figure D14. Ratios of applied load to hold-down force for multiple-panel SIPs with openings: Configuration 207.